

PCL Communication

**Industrial Serial Communication
Cards with ISA Interface**

User Manual

Copyright

The documentation and the software included with this product are copyrighted 2008 by Advantech Co., Ltd. All rights are reserved. Advantech Co., Ltd. reserves the right to make improvements in the products described in this manual at any time without notice. No part of this manual may be reproduced, copied, translated or transmitted in any form or by any means without the prior written permission of Advantech Co., Ltd. Information provided in this manual is intended to be accurate and reliable. However, Advantech Co., Ltd. assumes no responsibility for its use, nor for any infringements of the rights of third parties, which may result from its use.

Acknowledgements

Award is a trademark of Award Software International, Inc.

VIA is a trademark of VIA Technologies, Inc.

IBM, PC/AT, PS/2 and VGA are trademarks of International Business Machines Corporation.

Intel and Pentium are trademarks of Intel Corporation.

Microsoft Windows® is a registered trademark of Microsoft Corp.

RTL is a trademark of Realtek Semi-Conductor Co., Ltd.

ESS is a trademark of ESS Technology, Inc.

UMC is a trademark of United Microelectronics Corporation.

SMI is a trademark of Silicon Motion, Inc.

Creative is a trademark of Creative Technology LTD.

All other product names or trademarks are properties of their respective owners.

Part No. 2003543510

1st Edition

Printed in Taiwan

February 2005

Product Warranty (2 years)

Advantech warrants to you, the original purchaser, that each of its products will be free from defects in materials and workmanship for two years from the date of purchase.

This warranty does not apply to any products which have been repaired or altered by persons other than repair personnel authorized by Advantech, or which have been subject to misuse, abuse, accident or improper installation. Advantech assumes no liability under the terms of this warranty as a consequence of such events.

Because of Advantech's high quality-control standards and rigorous testing, most of our customers never need to use our repair service. If an Advantech product is defective, it will be repaired or replaced at no charge during the warranty period. For out-of-warranty repairs, you will be billed according to the cost of replacement materials, service time and freight. Please consult your dealer for more details.

If you think you have a defective product, follow these steps:

1. Collect all the information about the problem encountered. (For example, CPU speed, Advantech products used, other hardware and software used, etc.) Note anything abnormal and list any onscreen messages you get when the problem occurs.
2. Call your dealer and describe the problem. Please have your manual, product, and any helpful information readily available.
3. If your product is diagnosed as defective, obtain an RMA (return merchandise authorization) number from your dealer. This allows us to process your return more quickly.
4. Carefully pack the defective product, a fully-completed Repair and Replacement Order Card and a photocopy proof of purchase date (such as your sales receipt) in a shippable container. A product returned without proof of the purchase date is not eligible for warranty service.
5. Write the RMA number visibly on the outside of the package and ship it prepaid to your dealer.

CE

This product has passed the CE test for environmental specifications when shielded cables are used for external wiring. We recommend the use of shielded cables. This kind of cable is available from Advantech. Please contact your local supplier for ordering information.

FCC Class A

This equipment has been tested and found to comply with the limits for a Class A digital device, pursuant to Part 15 of the FCC Rules. These limits are designed to provide reasonable protection against harmful interference when the equipment is operated in a commercial environment. This equipment generates, uses and can radiate radio frequency energy and, if not installed and used in accordance with the instruction manual, may cause harmful interference to radio communications. Operation of this equipment in a residential area is likely to cause harmful interference in which case the user will be required to correct the interference at his own expense.

Technical Support and Assistance

- Step 1. Visit the Advantech web site at **www.advantech.com/support** where you can find the latest information about the product.
- Step 2. Contact your distributor, sales representative, or Advantech's customer service center for technical support if you need additional assistance. Please have the following information ready before you call:
 - Product name and serial number
 - Description of your peripheral attachments
 - Description of your software (operating system, version, application software, etc.)
 - A complete description of the problem
 - The exact wording of any error messages

Packing List

Before setting up the system, check that the items listed below are included and in good condition. If any item does not accord with the table, please contact your dealer immediately.

- PCL communication interface card
- Industrial communication driver, utility and user manual in ICOM CD-ROM

Safety Precaution - Static Electricity

Follow these simple precautions to protect yourself from harm and the products from damage.

1. To avoid electrical shock, always disconnect the power from your PC chassis before you work on it. Don't touch any components on the CPU card or other cards while the PC is on.
2. Disconnect power before making any configuration changes. The sudden rush of power as you connect a jumper or install a card may damage sensitive electronic components.

Contents

Chapter 1	Introduction	2
1.1	Description	2
1.2	Features	2
1.3	Specifications	3
1.4	Ordering Information	5
1.4.1	PCL Communication Cards	5
1.4.2	Accessories	6
	Table 1.1:ISA Communication Cards Selection Guide .	6
Chapter 2	Hardware Configuration	8
2.1	Initial Inspection.....	8
2.2	Jumper and Switch Locations	9
	Figure 2.1:PCL-740 Silk Screen	9
	Figure 2.2:PCL-741 Silk Screen	10
	Figure 2.3:PCL-743B/S Silk Screen	11
	Figure 2.4:PCL-745B/S Silk Screen	12
	Figure 2.5:PCL-746+ Silk Screen	13
	Figure 2.6:PCL-846A/B Silk	14
	Figure 2.7:PCL-849A/B/+L Silk Screen	15
	Figure 2.8:PCL-858A/B Silk Screen	16
2.3	Jumper Settings	17
2.3.1	How to Set Jumpers	17
	Figure 2.9:Jumper Setting	17
2.3.2	Card Configuration	17
2.3.3	Default Setting	18
	Table 2.1:Default setting of ISA Comm. Cards	18
2.3.4	Mode Selection	18
	Figure 2.10:Mode Selections for PCL-740	18
	Figure 2.11:Mode Selections for PCL-741	19
	Figure 2.12:Active and Passive Setting for Current Loop 19	
	Figure 2.13:Current Loop Link	20
	Figure 2.14:RS-422/485 Mode Selection for PCL-743B/ S, PCL-745B/S and PCL-846A/B 20	
	Figure 2.15:Enable Mode Selection for PCL-743B/S, PCL-745B/S and PCL-846A/B 21	
	Figure 2.16:RS-232/422/485 Mode selection for PCL- 746+ 21	
	Figure 2.17:Mode selection for PCL-746+	22
2.3.5	I/O Address and Interrupt Setup	22
	Figure 2.18:Standard or Enhanced Mode selection for PCL-746+ 22	
	Figure 2.19:Standard or Enhanced Mode selection for	

	PCL-846A/B	23
	Figure 2.20:Standard or Enhanced Mode selection for PCL-849A/B/+	23
	Figure 2.21:Port Base Address Setting	24
	Figure 2.22:Setting to 2F8	25
	Figure 2.23:Shared or Independent IRQ selection for PCL-746+	26
	Figure 2.24:Shared or Independent IRQ selection for S2 of PCL-746+ and S1 of PCL-849A/B/+	26
	Figure 2.25:IRQ Selection	27
2.3.6	Interrupt Status Register Setup (SW2 or S5)	27
2.3.7	Interrupt Status Register	28
	Figure 2.26:Vector Address Setting	28
	Figure 2.27:Vector Address Setting	28
2.3.8	Speed Mode selection	29
Chapter 3	Software Installation	32
3.1	Operating Environment Selection	32
	Figure 3.1:OS Jumper Selection	32
3.2	Driver Setup	32
3.2.1	Steps for Windows 98/2000/XP Driver Setup	32
3.3	Configuring ISA ICOM Serial Devices	39
3.4	Driver Uninstallation	42
Chapter 4	ICOM Tools	46
4.1	Introduction	46
4.2	Installation	46
4.3	User Interface of ICOM Tools	47
4.3.1	Menu Bar	47
4.3.2	Tool Bar	48
4.3.3	Com Port Tab	49
4.3.4	Port Status	50
4.3.5	Message Logo	50
4.3.6	Tx Slide Bar	51
4.3.7	Performance Listing Area	51
4.3.8	Status Bar	51
4.4	Using the ICOM Tools Utility	52
4.4.1	Port Selection	52
	Figure 4.1:ICOM Tools program window	52
	Figure 4.2:Select Port dialog box	53
	Figure 4.3:Ports You Select Will Appear in the Selected Port Checkbox Group	53
	Figure 4.4:ICOM Tools User Interface	54
4.4.2	Configuring a Port	54
	Figure 4.5:Test Information on the Performance Listing Area	55
4.4.3	Close Port	56

	4.4.4	Exit the ICOM Tools utility	56
4.5		Messages on Status Bar and Message Logo Area	57
	4.5.1	Status Bar Messages	57
	4.5.2	Message Logo Messages	58
Chapter 5		Pin Assignments and Wiring.....	60
5.1		Pin Assignments.....	60
	5.1.1	PCL-740 and PCL-741	60
		Figure 5.1:PCL-740 Pin Assignments	60
		Figure 5.2:PCL-741 Pin Assignments	60
	5.1.2	PCL-743B/S, PCL-745B/S, and PCL-846A/B	61
		Table 5.1:PCL-743B/S, PCL-745B/S Pin Description (DB-9 male) 61	
	5.1.3	PCL-746+ and PCL-849A/B/+L	61
		Figure 5.3:PCL-746+, PCL849A/B/+L RS-232 DB-37 Pin Assignments 61	
		Figure 5.4:PCL-746+, PCL849A/B/+L RS-232 DB-25 Pin Assignments 62	
		Figure 5.5:PCL-746+, PCL849A/B/+L RS-232 DB-9 Pin Assignments 62	
		Figure 5.6:PCL-746+ RS-422/RS-485 DB-37 Pin As- signments 63	
		Figure 5.7:PCL-746+ RS-422 DB-25 Pin Assignments .. 63	
		Figure 5.8:PCL-746+ RS-422 DB-9 Pin Assignments 64	
		Figure 5.9:PCL-746+ RS-485 DB-25 Pin Assignments .. 64	
		Figure 5.10:PCL-746+ RS-485 DB-9 Pin Assignments .. 64	
	5.1.4	PCL-858A/B	65
		Figure 5.11:PCL-858A/B RS-232 DB-62 Pin Assign- ments 65	
		Figure 5.12:PCL-858A/B with OPT8A+ RS-232 DB-25 Pin Assignments 66	
		Figure 5.13:PCL-858A/B with OPT8B+/C RS-232 DB- 25 Pin Assignments 66	
		Figure 5.14:PCL-858A/B with OPT8H RS-232 DB-9 Pin Assignments 66	
5.2		Wiring.....	67
	5.2.1	RS-232 Signal Wiring	67
		Table 5.2:Terminal or PC (DTE) connections	67
		Table 5.3:Modem Connections	68
		Table 5.4:Terminal without Handshake	68
	5.2.2	RS-422 Signal Wiring	69
		Table 5.5:PCL-743B/S, PCL-745B/S RS-422 Wiring Ta- ble 69	
	5.2.3	RS-485 Signal Wiring	70
		Figure 5.15:RS-485 Wiring Topology	70

5.3 Terminator Resistor Setup.....	70
------------------------------------	----

Introduction

This chapter introduces the PCL series and their specifications.

Sections include:

- Description
- Features
- Specification
- Ordering Information

Chapter 1 Introduction

1.1 Description

The ISA cards of the PCL Series provide an independent processor 16C550, 16C554 or 16C654 UART with an on-chip 16-byte or 64-byte FIFO buffer for reliable high-speed serial I/O. The UART buffers data into 16-byte or 64-byte packets before putting it on the bus. This drastically reduces the CPU's load and avoids data loss when the system is busy and can't process the interrupt quickly, which is especially useful for high speed serial I/O under Windows.

The ISA cards utilize onboard optical isolators to protect your PC and equipment against damage from ground loops, increasing system reliability in harsh environments. In order to meet the demand for reliability, the ISA cards also have surge protection technology. This surge protection can prevent damage from abrupt high voltage sources such as lightning power line strikes.

1.2 Features

- Speeds up to 921.6 kbps
- 16C550 with 16-byte FIFO
- 16C654 with 64-byte FIFO
- Wide IRQ selection
- OS supported: Windows 98/2000/XP, Linux
- Optional surge protection
- Optional isolation protection
- Complete RS-232 modem-control signal
- Space reserved for termination resistors
- LED indicator on each port indicates data flow
- RS-232, RS-422 or RS-485 modes jumper selectable
- Automatic RS-485 data flow control
- Support 2-wire or 4-wire operation
- ISA Configuration tools

1.3 Specifications

- **Bus interface:** ISA
- I/O address selection
- **Interrupt status register**
000H to 3F8H (for PCL-746+, PCL-858A/B)
200H to 3F8H (for PCL-740, PCL-741, PCL-743B/S, PCL-745B/S, PCL-846, PCL-849A/B/+L)
- **IRQ selection**
3,4,5,6,7,9,10,11,12 or 15 (for PCL-846A/B, PCL-849A/B/+L)
3,4,5,7,9,10,11,12 or 15 (for PCL-743B/S, PCL-745B/S, PCL-746+)
- **Communication controller**
16c550 for PCL-740, PCL-741, PCL-743B/S, PCL745B/S, PCL-746+, PCL-846A/B
16c554 for PCL-849A/B/L, PCL-858A/B
16c654 for PCL-849+
- **Stop bits:** 1,1.5,2
- **Data bits:** 5,6,7,8
- **Parity:** Even, odd and none
- **Speed (bps):**
Current loop: 50 ~ 57.6 k
Others: 50 ~ 921.6 k
- **Data Signal:**
TxD, RxD, RTS, CTS, DTR, DSR, DCD, RI and GND (for RS-232, PCL-740, PCL-741, PCL-746+, PCL-849A/B/+L, PCL-858A/B)
TxD+, TxD-, RxD+, RxD-, RTS+, RTS-, CTS+, CTS- and GND (for RS-422, PCL-743B/S, PCL745B/S, PCL-746+, PCL-846A/B)
DATA+, DATA- and GND (for RS-485, PCL-743B/S, PCL745B/S, PCL-746+, PCL-846A/B)
- **Dimensions:**
184 x 105 mm (for PCL-740, PCL-741, PCL-746+)
185 x 100 mm (for PCL-743B/S, PCL745B/S, PCL-746+, PCL-846A/B, PCL-858A/B)
185 x 98 mm (for PCL-746+, PCL849A/B/+)
158 x 75 mm (for PCL-849L)

- **Power Consumption**

	Typical	Max
PCL-740	250 mA (+5V)	350 mA (+5V)
PCL-741	300 mA (+5V)	1100 mA (+5V)
PCL-743B/S	400 mA (+5V)	950 mA (+5V)
PCL-745B/S	400 mA (+5V)	950 mA (+5V)
PCL-746+	800 mA (+5V)	1500 mA (+5V)
	60 mA ($\pm 12V$)	120 mA ($\pm 12V$)
PCL-846A/B	970 mA (+5V)	1200 mA (+5V)
PCL-849A/B/+L	250 mA (+5V)	500 mA (+5V)
	70 mA ($\pm 12V$)	120 mA ($\pm 12V$)
PCL-858A/B	450 mA (+5V)	950 mA (+5V)
	140 mA ($\pm 12V$)	240 mA ($\pm 12V$)

- **Operating Temperature** (refer to IEC 68-1.2.3)
 0~ 50° C (32~122° F) (for PCL-740, PCL741)
 0~ 60° C (32~140° F) (for PCL-846A/B, PCL-849A/B/+L,PCL-858A/B)
 0~ 65° C (32~149° F) (for PCL-743B/S, PCL-745B/S)
- **Operating Humidity:** 5 ~ 95% Relative Humidity, non-condensing
 (See IEC 68-2-3)
- **Storage Temperature**
 -25 ~ 80° C (-13~176° F) (for PCL-743B/S, PCL-745B/S, PCL-846A/B, PCL-849A/B/+L)
- **MTBF**
 PCL-743B/S: over 251,319 hrs at 25° C, Ground-fix environment
 PCL-745B/S: over 122,264 hrs at 25° C, Ground-fix environment
 PCL-846A: over 105,014 hrs at 25° C, Ground-fix environment
 PCL-846B: over 101,107 hrs at 25° C, Ground-fix environment
 PCL-849A/B/+L: over 135,000 hrs at 25° C, Ground-fix environment
 PCL-858A: over 99,100 hrs at 25° C, Ground-fix environment
 PCL-858B: over 92,363 hrs at 25° C, Ground-fix environment
- **Current-loop Interface**
 Signal Driver/receive: SN 75188, SN 75189 (for PCL-740)
 Signal Driver/receive: MAX-213 (for PCL-741)
- **Signals:** TxD+, TxD-, RxD+, RxD-

- **Current Value:** 4~20mA
- **Mode:** Asynchronous, full duplex
- **Baud-rate:** 50 ~ 57,600 bps
- **Transmission Distance:** 1000 m

1.4 Ordering Information

1.4.1 PCL Communication Cards

- **PCL-740:** RS-232/RS-422/RS-485/current-loop serial interface card
- **PCL-741:** Isolated dual-port RS-232/current-loop interface card
- **PCL-743B:** 2-port RS-422/485 communication card
- **PCL-743S:** 2-port RS-422/485 communication card with surge protection
- **PCL-745B:** 2-port RS-422/485 communication card with isolation protection
- **PCL-745S:** 2-port RS-422/485 communication card with isolation and surge protection
- **PCL-746+:** 4-port serial interface card. Includes 30-cm DB-37-to-DB-25 cable
- **PCL-846A:** 4-port RS-422/485 interface card w/isolation protection
- **PCL-846B:** 4-port RS-422/485 interface card w/isolation and surge protection
- **PCL-849A:** 4-port high-speed RS-232 interface card
- **PCL-849B:** 4-port high-speed RS-232 interface card w/ surge protection
- **PCL-849+:** 4-port high-speed RS-232 interface card w/ surge protection and 16C654 UART
- **PCL-849L:** 4-port RS-232 interface card
- **PCL-858A:** 8-port high-speed RS-232 interface card
- **PCL-858B:** 8-port high-speed RS-232 interface card w/surge protection

1.4.2 Accessories

- **OPT4A:** 4-Port RS-232/422/485 Cable Male DB9 Connector 30 cm
- **OPT8A+:** 8-Port RS-232 Connection Box/Female DB25 Connect (DCE) (1 m cable connector with card and connection box included)
- **OPT8AS:** 8-Port RS-232 Connection Box/Female DB25 Connector w/ surge protection (DCE) (1 m cable connector with card and connection box included)
- **OPT8B+:** 8-Port RS-232 Connection Box/Male DB25 Connector (DTE) (1 m cable connector with card and connection box included)
- **OPT8BS+:** 8-Port RS-232 Connection Box/Male DB25 Connector w/ surge protection (DTE) (1 m cable connector with card and connection box included)
- **OPT8C:** 8-Port RS-232 Octopus Cable/Male DB25 Connect 1 m
- **OPT8H:** 8-Port RS-232 Octopus Cable/Male DB9 Connect 1 m

Table 1.1: ISA Communication Cards Selection Guide

Model Name		Ports	Communication Interface Support	Protection	
				Surge	Isolation
PCL-740		1	RS-232/422/485/ Current loop	-	-
PCL-741		2	RS-232/Current loop	-	2,500 VDC
PCL-743	B	2	RS-422/485	-	-
PCL-743	S	2		2,500 VDC	-
PCL-745	B	2		-	3,000 VDC
PCL-745	S	2		2,500 VDC	3,000 VDC
PCL-746+		4	RS-232/422/485	-	-
PCL-846	A	4	RS-422/485	-	1,000 VDC
	B	4		2,000 VDC	1,000 VDC
PCL-849	A	4	RS-232	-	-
	B	4		3,000 VDC	-
	+	4		3,000 VDC	-
	L	4		2,000 VDC	-
PCL-858	A	8		-	-
	B	8		3,000 VDC	-

Hardware Configuration

This chapter shows how to configure your PCL card and then install it.

Sections include:

- Initial Inspection
- Jumper & Switch Location
- Jumper Settings
- Card Installation

Chapter 2 Hardware Configuration

2.1 Initial Inspection

You should find the following items inside the shipping package:

- PCL communication interface card
- Industrial Communication Driver, Utility and PCL communication card
- User manual in ICOM CD-ROM

We carefully inspected the PCL communication card series mechanically and electrically before we shipped it. It should be free of marks and scratches and in perfect working order on receipt.

As you unpack the PCL communication card series, check it for signs of shipping damage (damaged box, scratches, dents, etc.). If it is damaged or it fails to meet specifications, notify our service department or your local sales representative immediately. Also notify the carrier. Retain the shipping carton and packing material for inspection by the carrier. After inspection we will make arrangements to repair or replace the unit.

When you handle the PCL communication card series, remove it from its protective packaging by grasping the rear metal panel. Keep the anti-vibration packing. Whenever you remove the card from the PC, store it in this package for protection

Warning



Discharge your body's static electric charge by touching the back of the grounded chassis of the system unit (metal) before handling the board. You should avoid contact with materials that hold a static charge such as plastic, vinyl and Styrofoam.

Handle the board only by its edges to avoid static damage to its integrated circuits. Avoid touching the exposed circuit connectors. We also recommend that you use a grounded wrist strap and place the card on a static dissipative mat whenever you work with it.

2.2 Jumper and Switch Locations

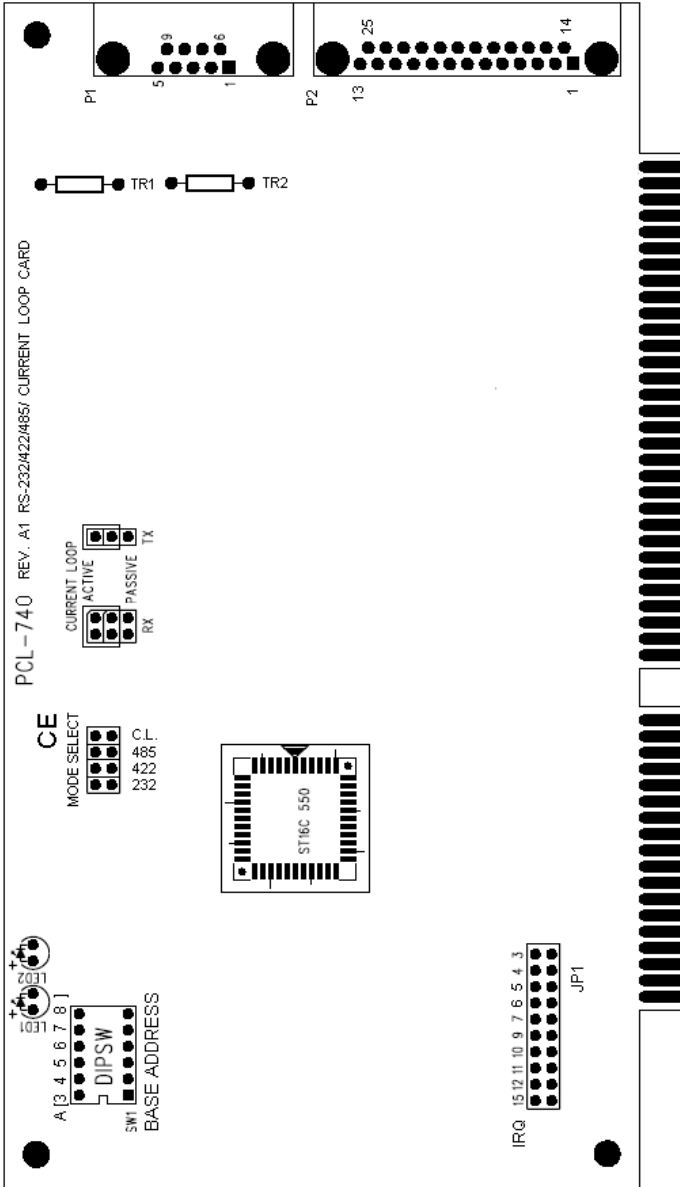

Figure 2.1: PCL-740 Silk Screen

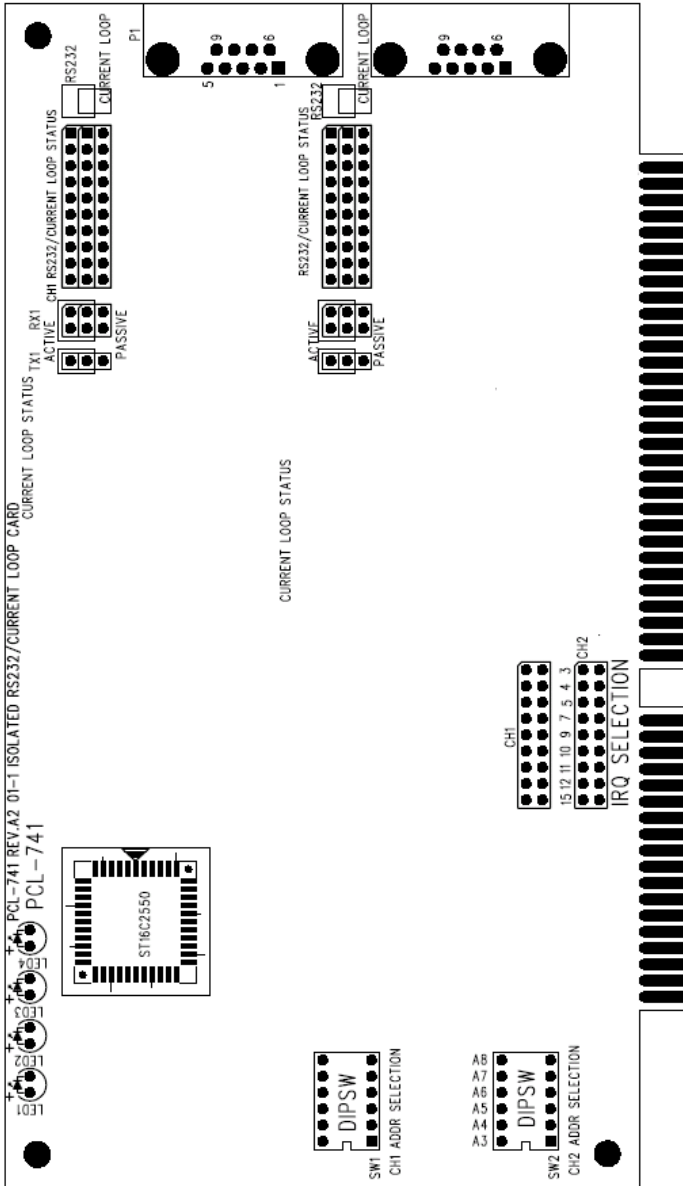

Figure 2.2: PCL-741 Silk Screen

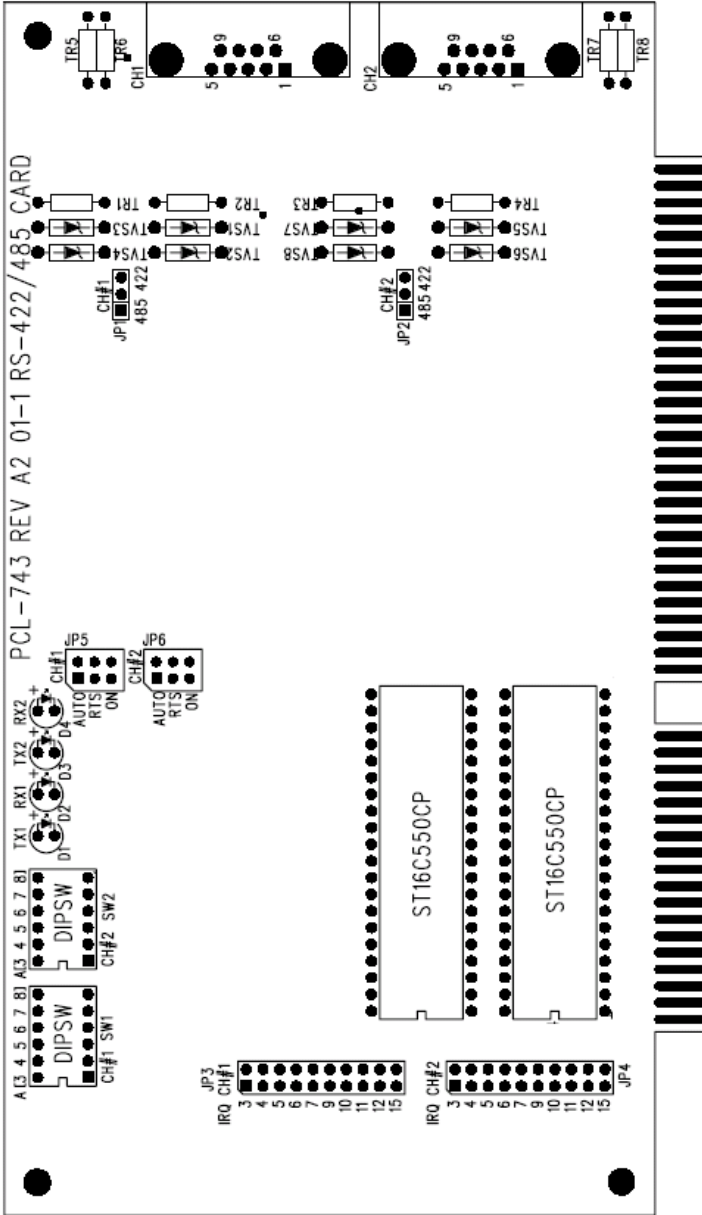

Figure 2.3: PCL-743B/S Silk Screen

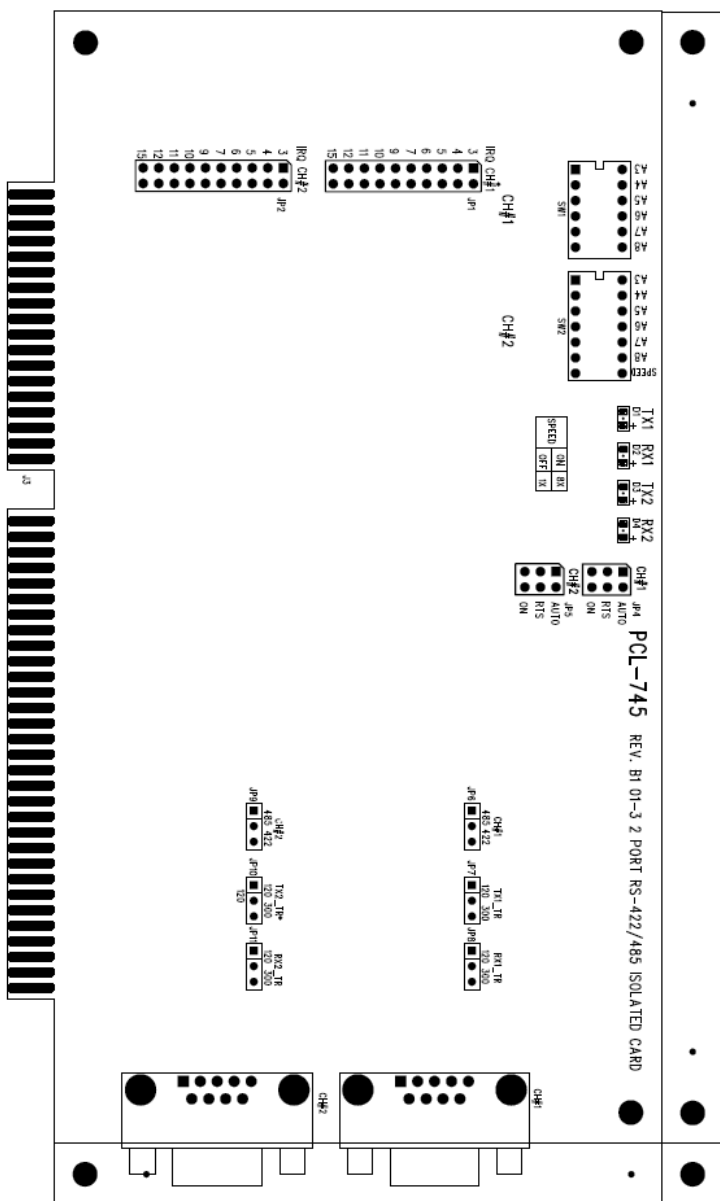

Figure 2.4: PCL-745B/S Silk Screen

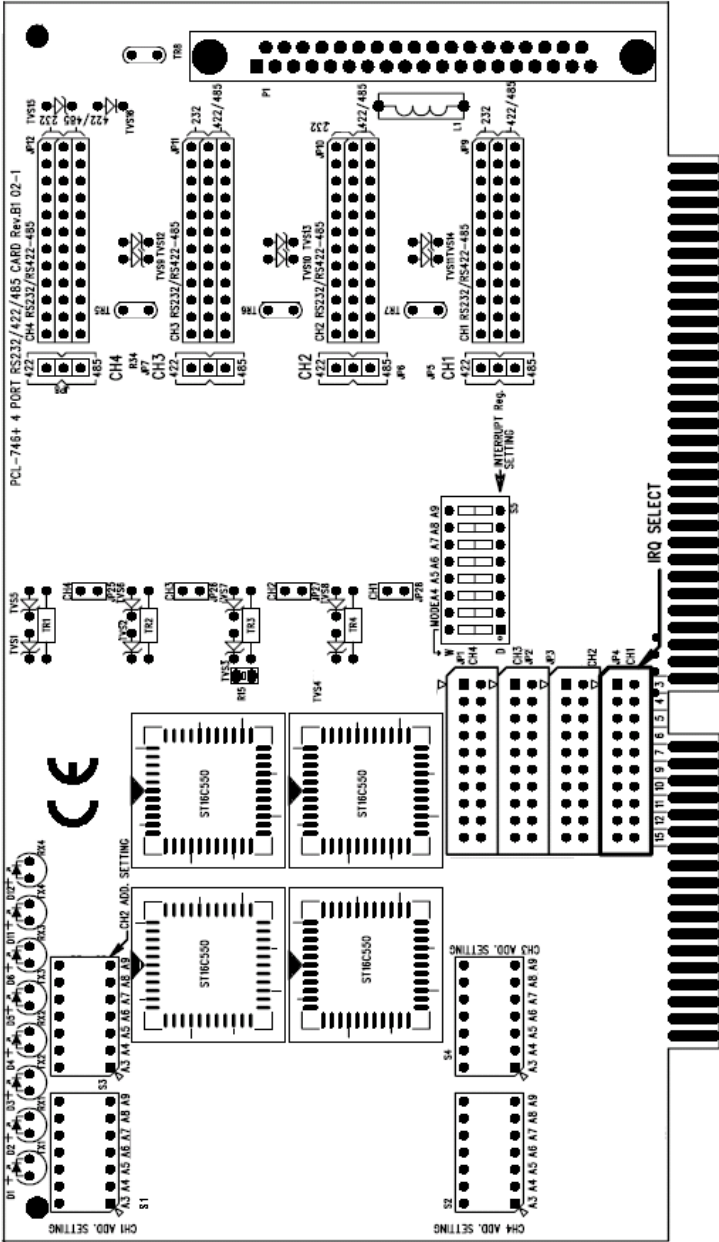

Figure 2.5: PCL-746+ Silk Screen

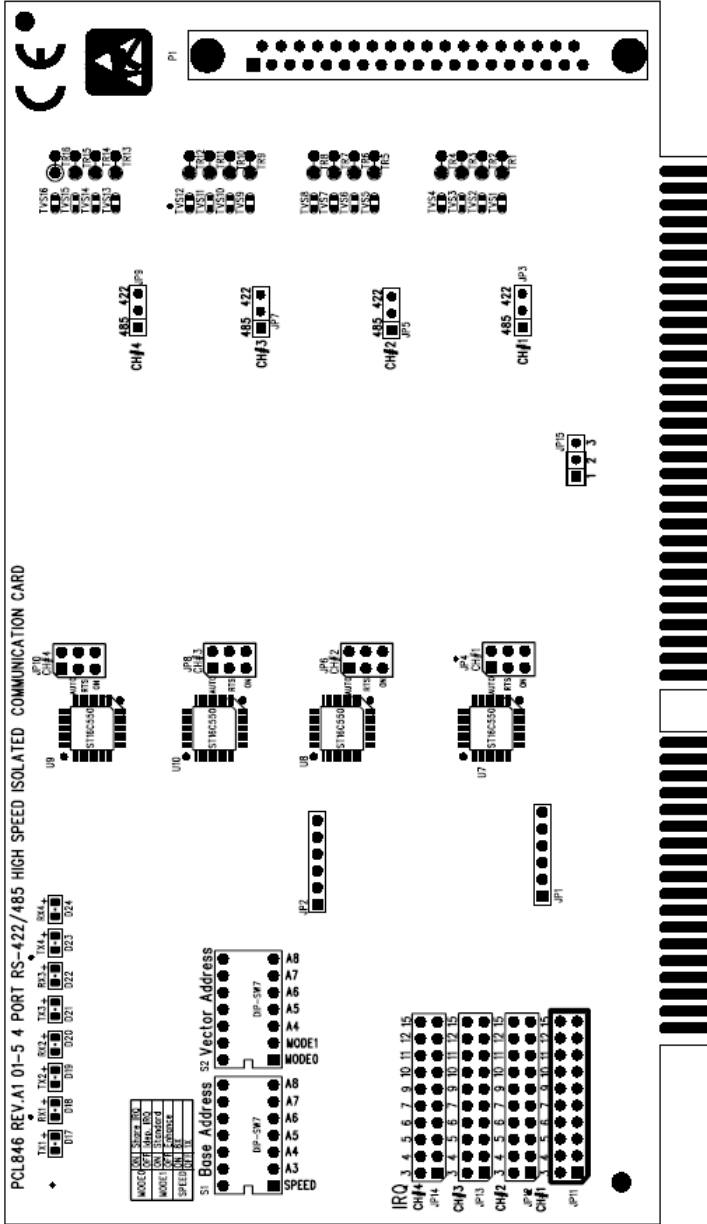

Figure 2.6: PCL-846A/B Silk

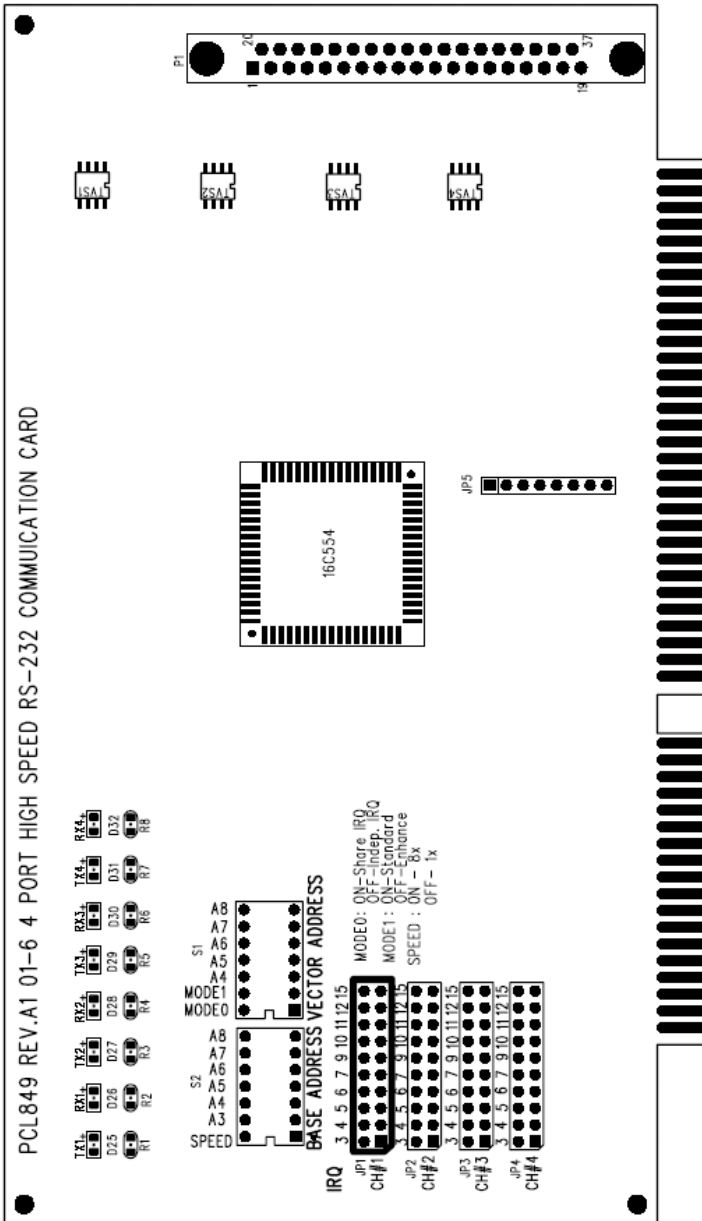

Figure 2.7: PCL-849A/B/+L Silk Screen

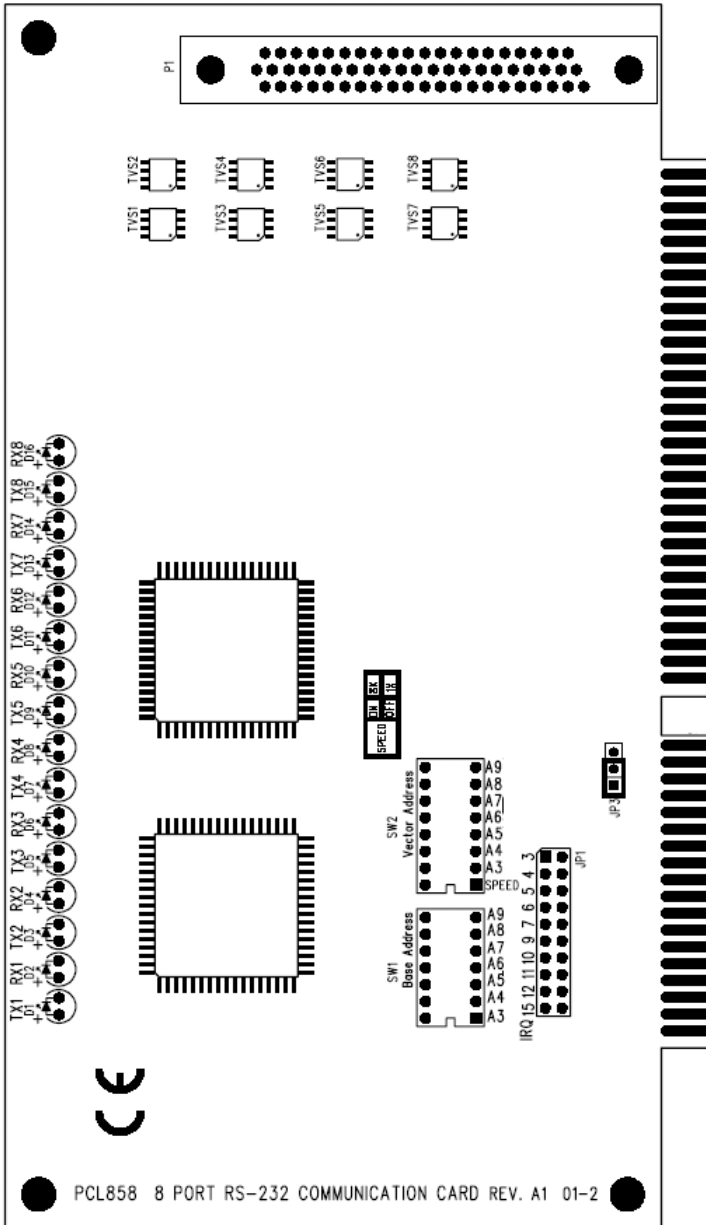

Figure 2.8: PCL-858A/B Silk Screen

2.3 Jumper Settings

This section tells how to set the jumpers to configure your card. It gives the card default configuration and your options for each jumper.

2.3.1 How to Set Jumpers

You configure your card to match the needs of your application by setting jumpers. A jumper is the simplest kind of electric switch. It consists of two metal pins and a small metal clip (often protected by a plastic cover) that slides over the pins to connect them. To close a jumper you connect the pins with the clip. To open a jumper you remove the clip.

Sometimes a jumper will have three pins, labeled 1, 2 and 3. In this case you would connect either pins 1 and 2 or 2 and 3.

You may find a pair of needle-nose pliers useful for setting the jumpers.

If you have any doubts about the best hardware configuration for your application, contact your local distributor or sales representative before you make any changes.

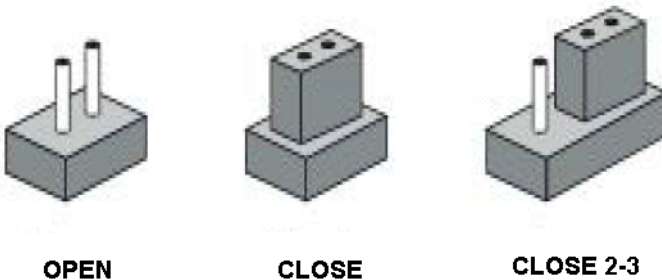

Figure 2.9: Jumper Setting

2.3.2 Card Configuration

The DIP switch sets the port to the appropriate I/O address and speed mode. The jumpers set the port's mode (RS-232, RS422, RS485 or Current Loop) or IRQ.

2.3.3 Default Setting

The board is shipped with default settings. If you need to change these settings, however, see the following sections. Otherwise, you can simply install the card. Note that you will need to disable your CPU card's on-board COM ports, if any, or set them to alternate addresses / IRQ.

Table 2.1: Default setting of ISA Comm. Cards

Card	PCL-740	PCL-741	PCL-743B/S, PCL-745B/S	PCL-746+	PCL-846	PCL-849A/B/ +/L PCL-858
Mode Selection	RS-232	RS-232	RS-422	RS-232	RS-422	RS-232
Base Address	3F8	3F8 & 2F8	3F8 & 2F8	Address 300H	Address 300H	Address 300H
Vector Address	-	-	-	Interrupt 280H	Interrupt 280H	Interrupt 280H
IRQ Mode	-	-	-	Share	Share	Share
IRQ	4	4 & 3	4 & 3	12	12	12
Speed Mode	-	-	1x	1X	1X	1X

2.3.4 Mode Selection

PCL-740 and PCL-741

First, you have to decide which mode each port will operate in. There is RS-232, RS-422, RS-485 or current-loop driver mode for PCL-740, and RS-232 or current-loop for PCL-741.

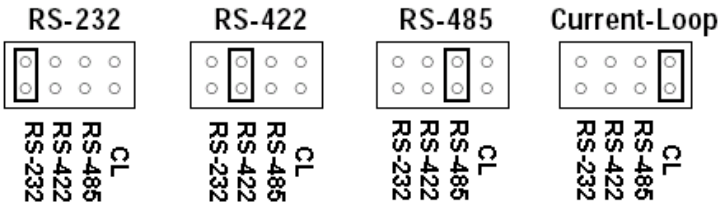

Figure 2.10: Mode Selections for PCL-740

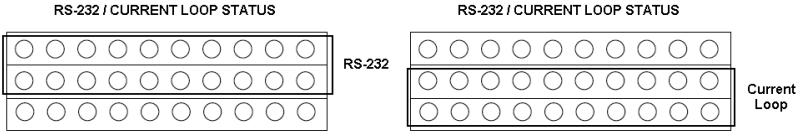

Figure 2.11: Mode Selections for PCL-741

Note: When RS-232, RS-422 or RS-485 mode is selected, current-loop Tx/Rx active/passive jumpers are inoperable.

Should you want to configure the PCL-740 or PCL-741 to operate in the current loop mode, configure the main jumper for current-loop. You also have to set Tx and Rx for active or passive mode. In the active mode the Tx or Rx will generate the current required for data transfer over the link. In the passive mode the current is generated by the card at the other end of the link. You may configure both the Tx and Rx to operate in the same mode, or you can configure each Tx and Rx to operate in different modes.

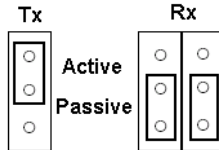

Figure 2.12: Active and Passive Setting for Current Loop

Note: Whatever mode you select, you must ensure that this is not the same mode as the device that PCL-740 or PCL-741 is connected to. The diagram below shows a typical configuration.

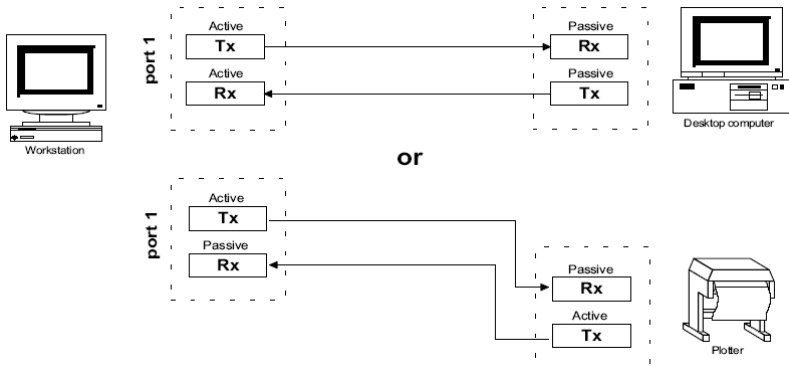

Figure 2.13: Current Loop Link

PCL-743B/S, PCL-745B/S, PCL-846A/B

You can set each port individually for either RS-422 (the default) or RS-485 operation. The figure below shows the jumper settings.

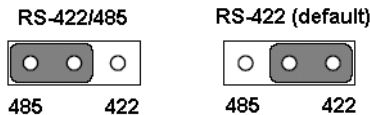

Figure 2.14: RS-422/485 Mode Selection for PCL-743B/S, PCL-745B/S and PCL-846A/B

Enable Mode Selection

Jumpers set the driver enable mode selections of every port respectively. If a jumper is set to "AUTO," the driver automatically senses the direction of the data flow and switches the direction of transmission. No handshaking is necessary.

If a jumper is set to "RTS" (request to send), a high RTS signal will enable the driver. Otherwise, the driver output will remain in high impedance status.

If a jumper is set to "ON," the driver is always enabled, and always in high or low status. The user must select a mode before beginning RS-422 applications.

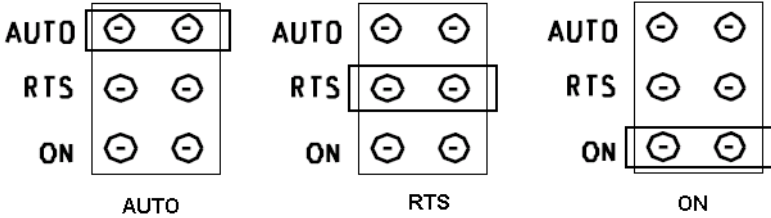

Figure 2.15: Enable Mode Selection for PCL-743B/S, PCL-745B/S and PCL-846A/B

PCL-746+

Should you wish to configure the PCL-746+ to operate in the RS-232 mode, then the upper two pins of the 12*3 pin jumper should be connected. For RS-422/ RS-485 mode selection, the bottom two pins of the 12*3 pin jumper should be connected as shown below.

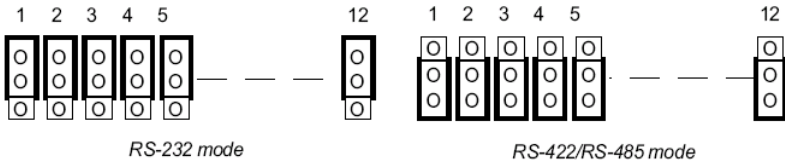

Figure 2.16: RS-232/422/485 Mode selection for PCL-746+

For either RS-422 or RS-485 mode selection the 1*3 pin jumpers for each port have to be configured. For RS-422 configuration the upper two pins of the 3-pin jumper should be connected. A 2-pin jumper is used for Tx control. Closing the jumper initiates Tx automatic flow control. An open jumper means that Tx is always on. For RS-485 configuration the bottom two pins of the 3-pin jumper should be connected and the 2-pin jumper is always closed as shown below.

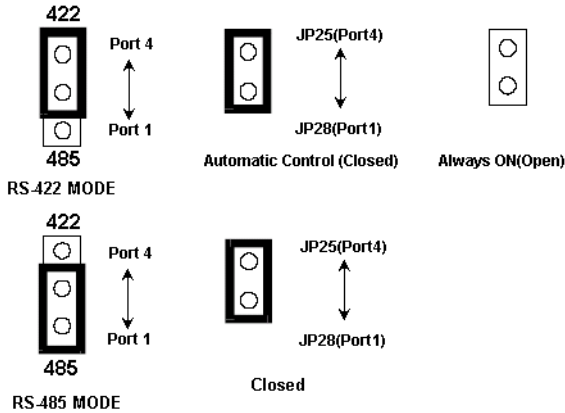

Figure 2.17: Mode selection for PCL-746+

2.3.5 I/O Address and Interrupt Setup

Next, you will need to select an IRQ (interrupt request) number, and an I/O base address for the Card. In PCL-746+, PCL-846A/B and PCL-849A/B/+, you can choose standard mode or enhanced mode. For other cards such as PCL-740, PCL-741, PCL-743B/S, PCL-745B/S, PCL-849L and PCL-858A/B, the cards are designed for enhanced mode.

Mode Setup (S5 for PCL-746+, S2 for PCL-846A/B and S1 for PCL-849A/B/+)

The card base address can be set using the DIP switches on the card. The DIP switch labeled "MODE 1" will set the card to standard or enhanced mode, as shown below. You can select standard or enhanced mode in PCL-846A/B, but PCL-858A/B are designed for enhanced mode.

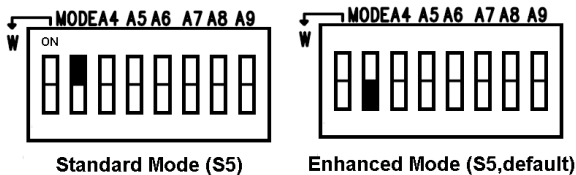

Figure 2.18: Standard or Enhanced Mode selection for PCL-746+

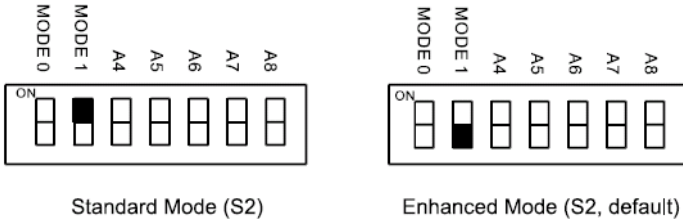

Figure 2.19: Standard or Enhanced Mode selection for PCL-846A/B

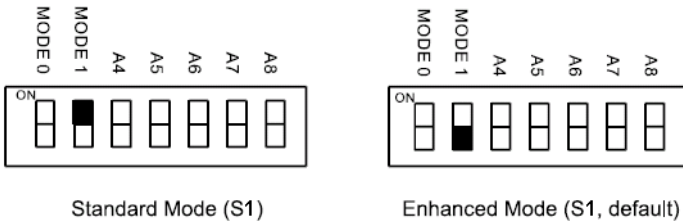

Figure 2.20: Standard or Enhanced Mode selection for PCL-849A/B/+

Standard Mode

In this mode each of the four ports can be setup as the address or the IRQ channel individually.

Port	Base Address
1	3F8
2	2F8
3	3E8
4	2E8

Enhanced Mode

In this mode all four ports share the same IRQ and continue to use the cards designated IRQ address. This mode also utilizes an interrupt status register designed to indicate which serial port has generated an interrupt. This mode speeds up interrupt processing resulting in a greater throughput for each multi-port card.

Base address setting (SW1 or S2)

For base address specify the I/O address of the first port and subsequent ports are set continuous base addresses by the offset of 8 bytes. For instance, if the first port is set for 300H, then the second port is set to 308H sequentially. For 8 ports, specify the continuous PORT number of the first port and subsequent ports are mapped to continuous PORT numbers. For example:

Port	Address
1	Address 300H
2	Address 308H
3	Address 310H
4	Address 318H
5	Address 320H
6	Address 328H
7	Address 330H
8	Address 338H

Select an address, which is not already in use by another card in the system. If you are installing more than one card in your system, set the card to different base address. DIP switch (SW1) controls each card's base address, as shown below.

Port base address (SW1)							
Base Address	A ₃	A ₄	A ₅	A ₆	A ₇	A ₈	A ₉
200-21F	●	●	●	●	●	●	○
208-227	○	●	●	●	●	●	○
.....							
2E8-307	○	●	○	○	○	●	○
.....							
*300-31F	●	●	●	●	●	○	○
.....							
3E0-3FF	●	●	○	○	○	○	○

● : on ○ : off * = default

Figure 2.21: Port Base Address Setting

The following example shows how to set the base address to 2F8. The switch sum is set to 2F8: 200 + 80 + 40 + 20 + 10 + 8 (HEX).

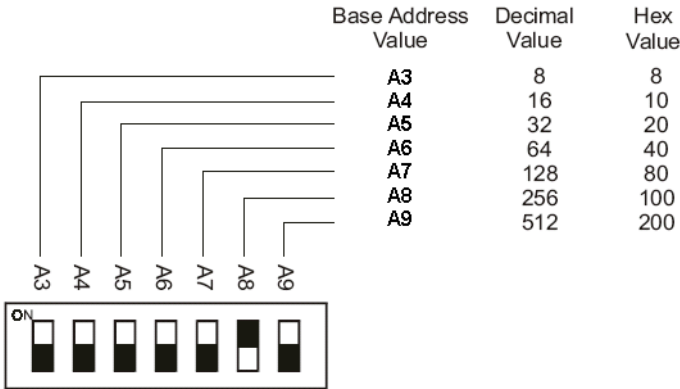

Figure 2.22: Setting to 2F8

Note: On the PCL-740, PCL-741, PCL-743B/S, PCL-745B/S, PCL-846, PCL-849A/B/+L address line A9 does not appear on the DIP switch, as it is permanently hardwired to hex 200.

Interrupt Level (IRQ) Setting

In PCL-746+, PCL-846A/B and PCL-849A/B/+, you can choose shared IRQ or Independent IRQ. For other cards such as PCL-740, PCL-741, PCL-743B/S, PCL-745B/S, PCL-849L and PCL-858A/B, the cards are designed for shared IRQ.

IRQ mode select

In PCL-746+, PCL-846A/B and PCL-849A/B/+, you can choose shared IRQ or Independent IRQ.

The card's IRQ mode can be set using S1 for PCL-849A/B/+, S2 for PCL-846A/B and S5 for PCL-746+. Please note that the DIP switch on the labeled MODE 0 is for setting the mode, as shown below.

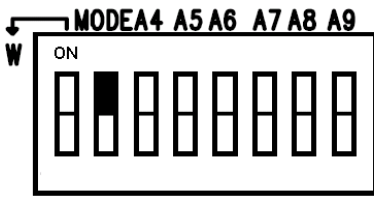

Independent IRQ (S5)

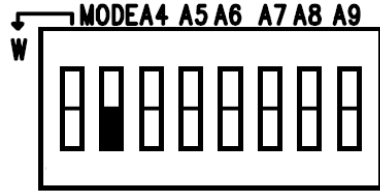

Share IRQ (S5, default)

Figure 2.23: Shared or Independent IRQ selection for PCL-746+

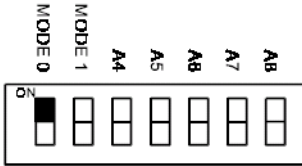

Shared IRQ Mode (default)

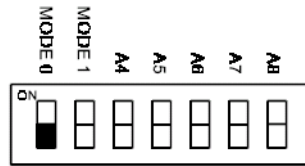

Independent IRQ Mode

Figure 2.24: Shared or Independent IRQ selection for S2 of PCL-746+ and S1 of PCL-849A/B/+

Independent IRQ Mode

In this mode, each of the four ports can have IRQ channels set individually. For each port, select an IRQ, which is not already in use by another card in the system. The mapping of jumpers to ports is as shown below.

Port	PCL-746+ Jumper	PCL-846A/B Jumper	PCL-849A/B/+ Jumper
1	JP4	JP11	JP1
2	JP3	JP12	JP2
3	JP2	JP13	JP3
4	JP1	JP14	JP4

Shared IRQ Mode

In this mode, all channels in card share the same interrupt (IRQ), and interrupt status register is available for determining the interrupt source. Select an IRQ, which is not already in use by another card in the system. If you are installing more than one card, set them to different IRQ number. Jumper Bank JP1 controls the card IRQ. Simply place the jumper on the interrupt level as shown in the following figure. You can set share IRQ selection as the following table shows.

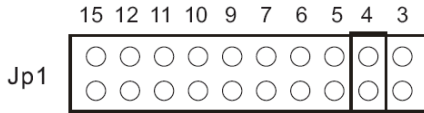

Figure 2.25: IRQ Selection

Item	Jumper
PCL-746+	JP4
PCL-846A/B	JP11
PCL-849A/B/+	JP1

2.3.6 Interrupt Status Register Setup (SW2 or S5)

When data arrives at one of the eight ports, it will generate an interrupt in the interrupt register. The software can read this, and identify immediately which port generated the interrupt. This saves time, and makes programming easier. In Windows 98/2000/XP environment, when a data bit of the interrupt status register is set to 1, the corresponding channel is select to generate an interrupt. If the bit is 0, then no interrupt status register, as shown in the following figure and table.

2.3.7 Interrupt Status Register

Bit	Function
0	Port 1
1	Port 2
2	Port 3
3	Port 4
4	Port 5
5	Port 6
6	Port 7
7	Port 8

You may change the interrupt status address via SW2 or S5. Please note the address decoder will occupy a continuous, 8-byte area related to switch setting. For example, if you set the switch to 210H, the addresses 210H to 217H will all be decoded. The various DIP switch settings (SW2 or S5) for the interrupt status register are shown in the figure below.

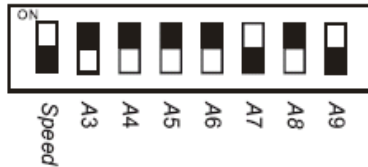

Figure 2.26: Vector Address Setting

Vector Address (SW2)	A ₃	A ₄	A ₅	A ₆	A ₇	A ₈	A ₉
200H	●	●	●	●	●	●	○
210H	●	○	●	●	●	●	○
.....							
250H	●	○	●	○	●	●	○
.....							
300H	●	●	●	●	●	○	○
.....							
3F0H	●	○	○	○	○	○	○

● : on ○ : off

Figure 2.27: Vector Address Setting

Note: On PCL-849A/B/+/L address line A9 does not appear on the DIP switch, as it is permanently hardwired to hex 200.

2.3.8 Speed Mode selection

PCL-735B/S, PCL-745B/S, PCL-746+, PCL-846A/B and PCL-858A/B employ a unique speed option that allows the user to choose either normal speed mode (1x) or high speed mode (8x). The high speed mode is selected with SW2.

Normal Speed Mode

To select the baud rate commonly associated with COM ports, such as 2400, 4800, 9600 bps, or 115.2 kbps, place the switch as follows.

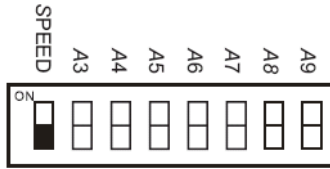

High Speed Mode

To increase normal mode rates up to eight times, (e.g. if 115.2 kbps is selected, the rate can be increased up to 921.6 kbps), place the switch as follows.

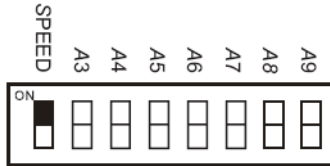

Software Installation

This chapter shows to how install the driver and then configure your PCL card.

Sections include:

- Operating Environment Selection
- Driver Setup
- Configuring ISA ICOM Serial Devices
- Driver Uninstallation

Chapter 3 Software Installation

3.1 Operating Environment Selection

Set jumper 3 (JP3) to correspond with the supported operating environment. Connect the two pins on the right to operate in Windows 98/2000/XP mode as shown below.

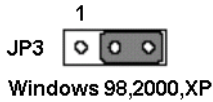

Figure 3.1: OS Jumper Selection

Note *Setting the pin to 1-2 is for DOS and Windows 3.1, which was supported before 2005. From 2005, Advantech's PCL cards no longer supports DOS and Windows 3.1.*

3.2 Driver Setup

Windows 98/2000/XP supports COM1 to COM256, meaning up to 256 serial ports. In order to fully utilize the advanced features of Windows 98/2000/XP, such as multi-process and multithread, pure 32-bit Windows 98/2000/XP device drivers are provided for the ISA communication cards. All these drivers conform to the Win32 COMM API standard.

3.2.1 Steps for Windows 98/2000/XP Driver Setup

Before you install the card into your system, *we recommend you install the driver first*. Please follow the steps below for the ISA communication card's Windows 98/2000/XP driver installation.

1. Insert your companion CD-ROM disc into your CD-ROM drive.
2. The driver setup program will be launched automatically. If the auto-play function is not enabled on your system, use Windows Explorer or the Windows Run command to execute **autorun.exe** on the companion CD-ROM. You'll see the screen on the next page, where you should click *Continue*.



3. Click the *Installation* button to start installation.



- Click **ICOM Card Drivers** for Installation

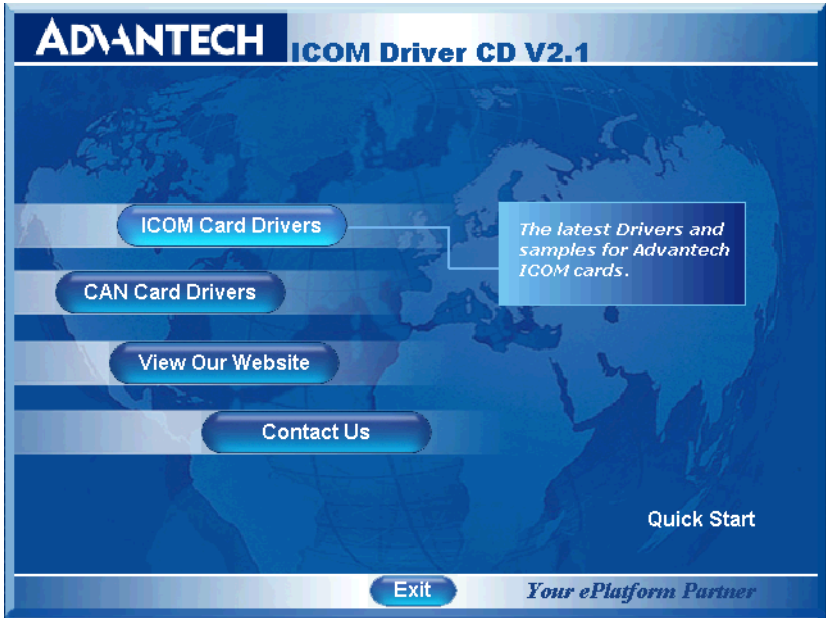

- Choose the product you want to install, and then click the hyper-link.

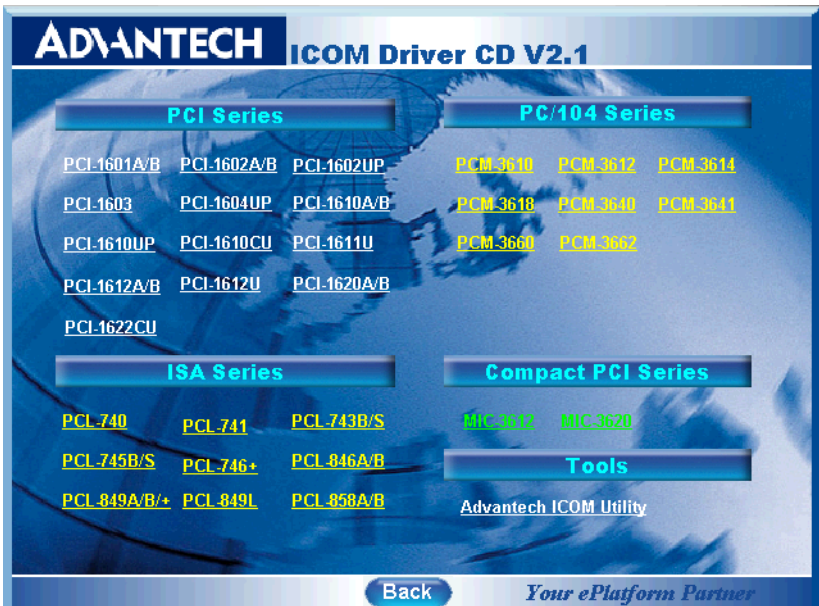

6. Click *Next* to continue installation.

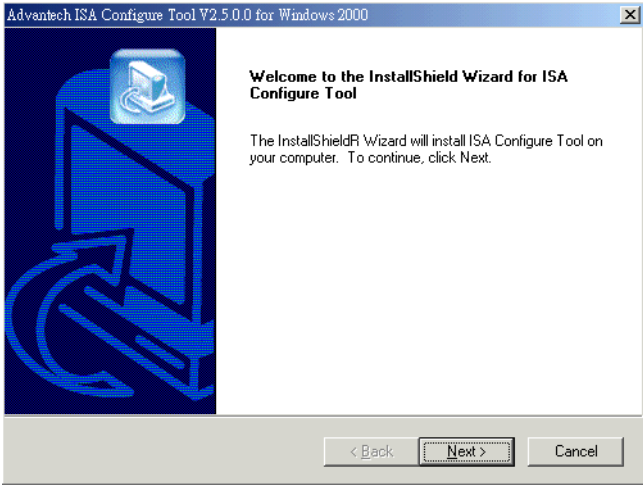

7. Type a user name and company name, then click Next.

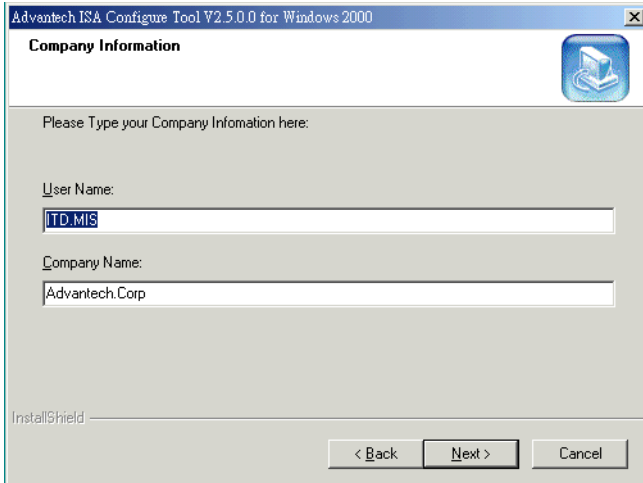

8. Click **Next** to accept the default installation folder, or specify a folder by clicking the **Browse** button.

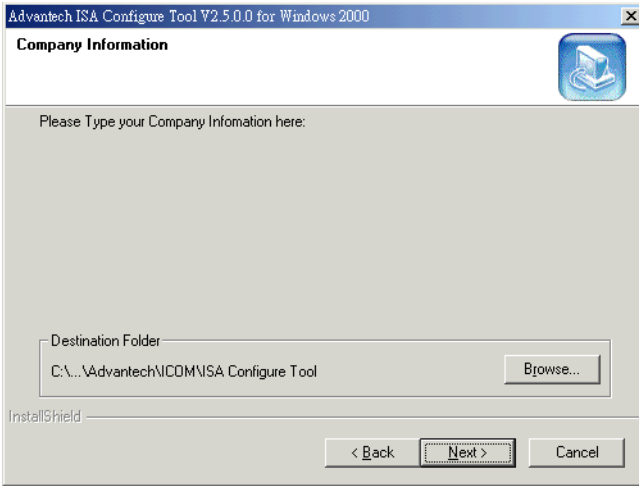

9. Choose tools and click **Next**.

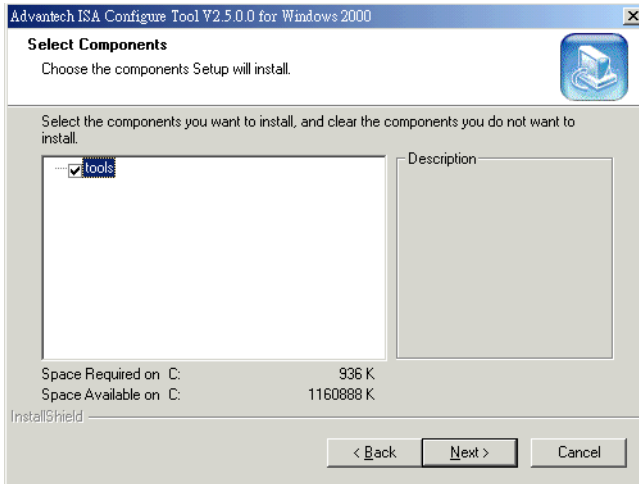

10. Confirm the program folder and click *Next*.

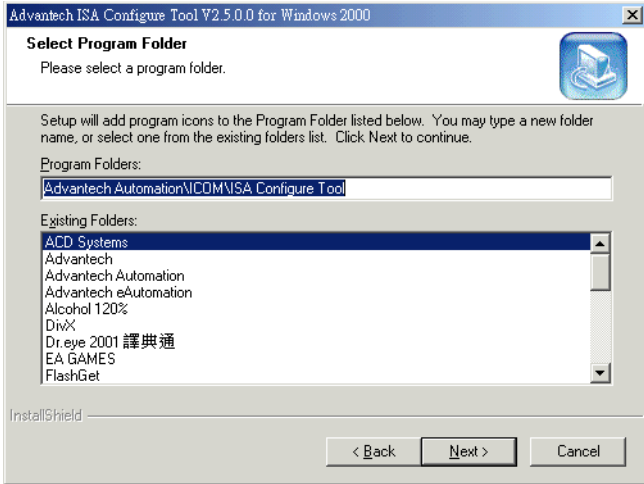

11. Click *Back* to review or change your settings, or click *Next* to begin copying files.

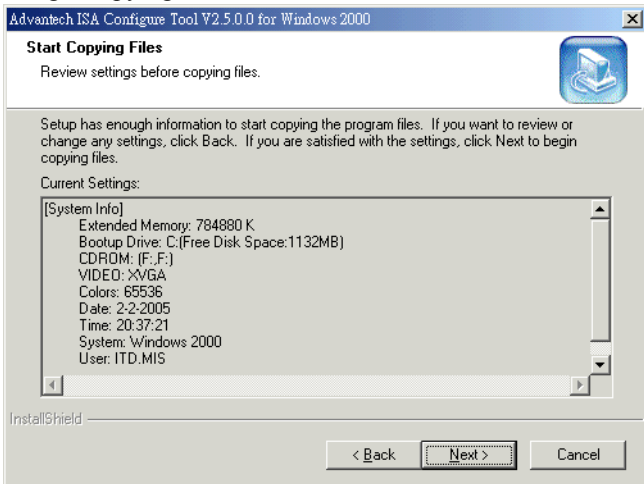

12. Click **Finish** to complete the installation.

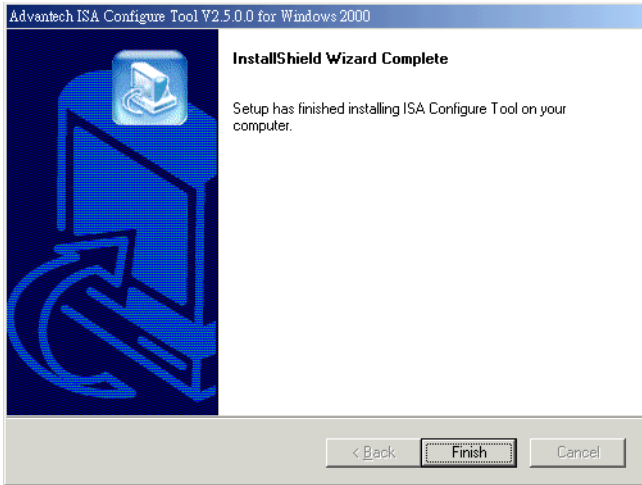

3.3 Configuring ISA ICOM Serial Devices

After you install the driver, you can configure it in the ISA Configuration Tool. Please follow the steps below to set up the ISA communication card's configuration tool.

1. Execute the program from the Taskbar [Start] button, and then select [Programs] menu, then [Advantech Automation] menu and then [ICOM] icon and then [ISA Configure Tool] icon and execute the ISA Configure Tool.
2. You can see the configuration screen.

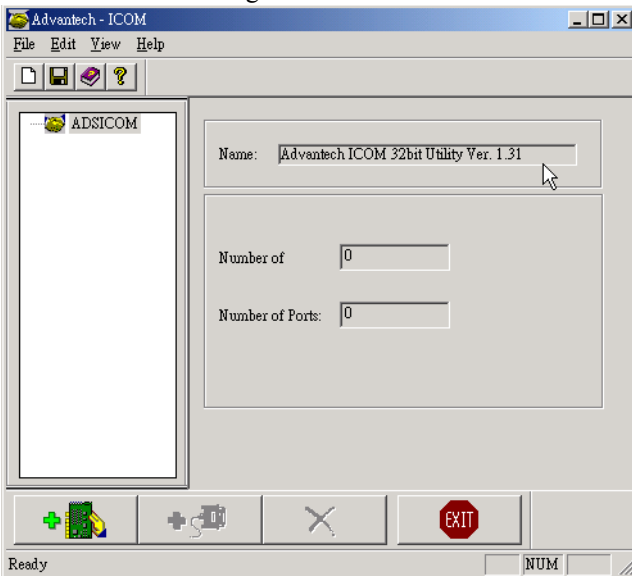

3. Click the Add Board button to add a board.

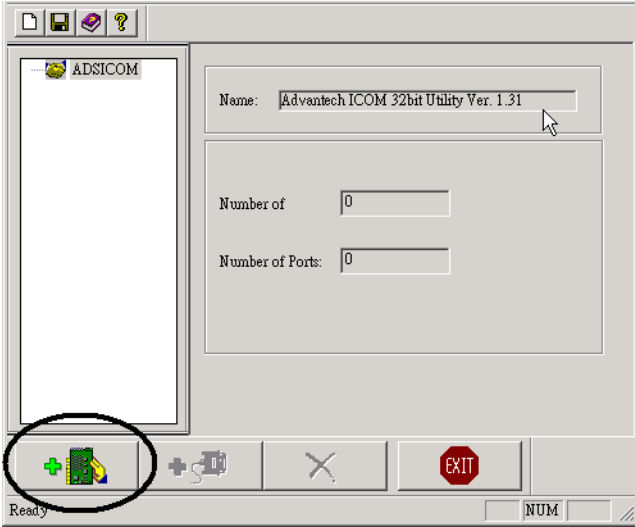

4. Choose the **Board Type** you want to install, and set up the **Base Address**, Specify the base address of the first port and subsequent base address is mapped to continuous COM numbers. For instance, if the first port is mapped to 300H, then the second port is mapped to 308H sequentially. **Base port Name**, Specify the COM number of the first port and subsequent ports are mapped to continuous COM numbers. For instance, if the first port is mapped to COM10, then the second port is mapped to COM11 sequentially. **IRQ setting**, 3,4,5,6,7,9,10,11,12 or 15 and **Vector Address**, 000H ~ 3F8H.

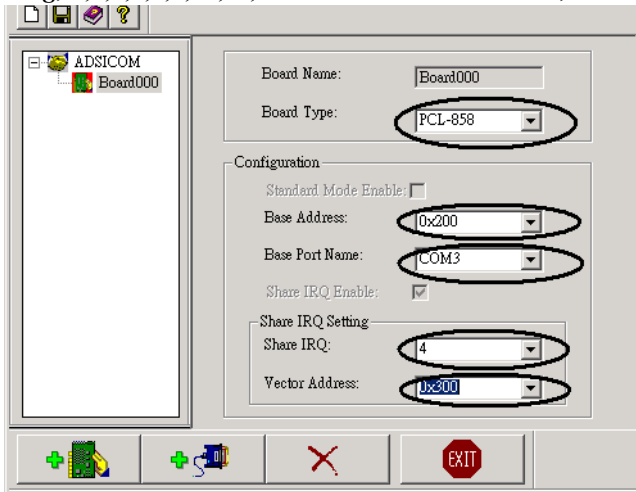

5. After all configuration are set up, click **add a new port**. Configuration will assign all ports automatically.

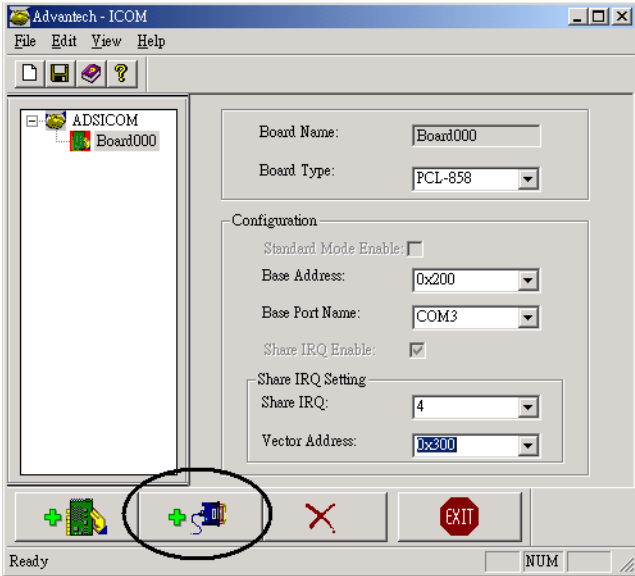

6. You will see information about all ports, and should click exit to restart your system. Unless the system is restarted, the changed configurations won't be saved.

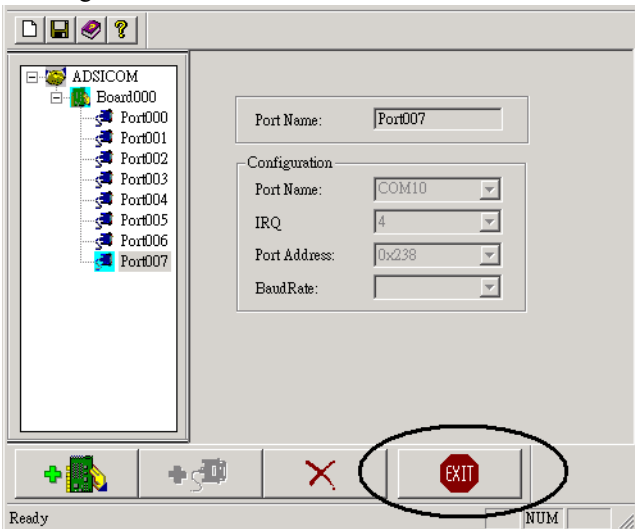

3.4 Driver Uninstallation

You have to remove the original device you installed, the COM port in Window's device manager and uninstall the driver before installing another model from Advantech's ISA ICOM series devices. Please follow the below steps for uninstalling the driver.

1. Insert the ICOM CD and choose the product that you want to uninstall the driver for.

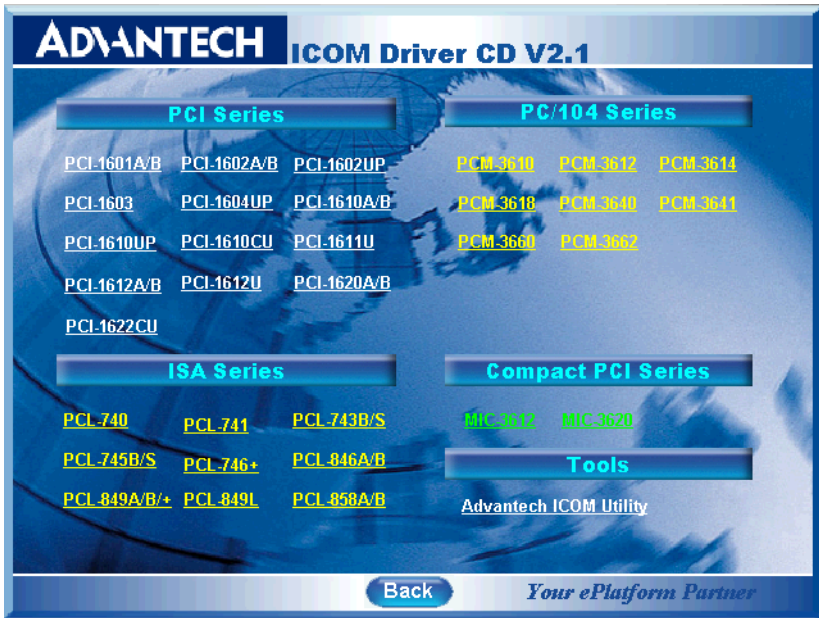

2. Click **Remove** and **Next** button to remove all installed components.

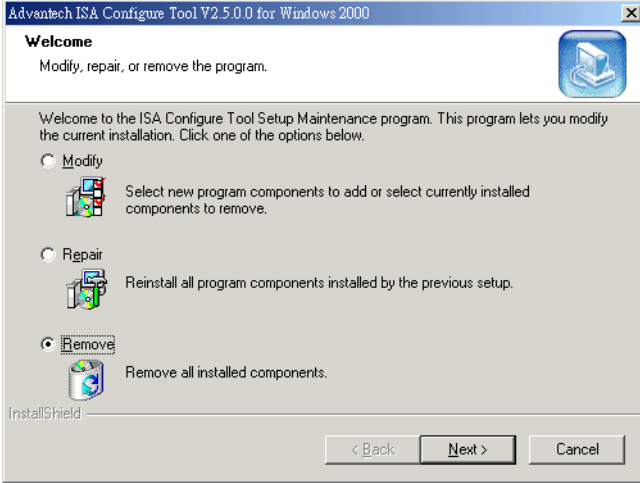

3. Click the **Finish** button to complete the uninstall

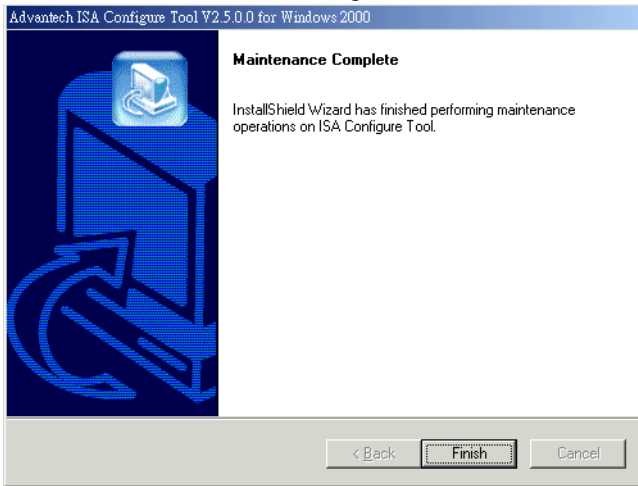

Note: *We recommend you to remove both the original device and COM port in Window's device manager and driver before installing another model of Advantech ISA ICOM series device.*

ICOM Tools

This chapter provides information on installation and usage of ICOM Tools.

Sections include:

- Introduction
- Installation
- User Interface of ICOM Tools

Chapter 4 ICOM Tools

4.1 Introduction

Advantech ICOM Tools is a convenient utility that has been designed to help you test the performance of ICOM cards through analyzing the port status. It features an easy to use graphical user interface that will soon make you familiar with testing via menu commands and toolbar buttons.

Advantech ICOM Tools is applicable to all series of Advantech ICOM cards, and can even be used with other third-party ICOM cards. It is included for free on the diskette or on the companion CD-ROM with all Advantech Industrial Communication cards.

4.2 Installation

To begin installation, double-click the ICOM_Tools.exe program icon in the Tools folder or click the Advantech ICOM Utility hyperlink in the installation window to launch the **ICOM Tools** setup program. The setup program will copy the program files to the destination folder you choose or to the default installation path (i.e. C:\Program Files\Advantech\ICOM Tools). A program folder will be created in your Start/Programs menu. (Later you can just access the program through:

Start/Program/Advantech Automation/ICOM/ICOM Tools/

4.3 User Interface of ICOM Tools

4.3.1 Menu Bar



Port All Ports Help

On the Menu Bar you can select various menu commands to perform port-testing functions. You can also use the short-cut keys.

Port Submenu

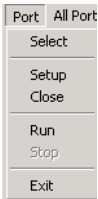

Select: Select the ports you want to configure

Setup: Setup the configuration of a specific port

Close: Close a specific port

Run: Run the test on a specific port

Stop: Stop the test on a specific port

All Ports Submenu



Setup: Setup the configurations of all ports

Run: Run the test on all ports

Stop: Stop the test on all ports

Help Submenu Access Online help

4.3.2 Tool Bar



Using the **Tool Bar** buttons is a more intuitive way to implement the functions of **ICOM Tools**.



Port Select: Selects the port(s) you want to perform testing on



Port Setup: Sets up configuration of the port you have selected



Port Close: Closes the port you have selected



Port Run: Runs the port test on the port you have selected



Port Stop: Stops the port test on the port you have selected



All Ports Setup: Sets up the configuration of all ports not running test



All Ports Run: Runs test on all ports



All Ports Stop: Stops test on all ports



Clear Message: Clears messages on Message Logo area and the Rx length information on the Performance Listing area

4.3.3 Com Port Tab

Each Com Port tab represents a specific port you have selected for test and configuration. On the tab, you can see the Transfer Mode, Port Status, and Message Logo area.

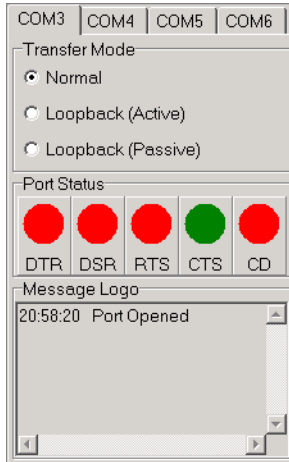

Transfer Modes

You can specify the transfer mode to be Normal, loopback (active) or loopback (passive).

Normal—allows data to be transmitted and received simultaneously. The data reception rate is helpful in identifying the performance of a communication card installed on your system.

Loopback- In loopback mode a series of special data will be transmitted, which are expected to appear on the receiving end. Using the loopback mode, you can check the integrity of received data and find whether any error occurred on the transmission line. The active loopback and passive loopback must work in pair to enable the loopback mode. When a port operates as active loopback mode, it will send data first and receive data later. Another port, which operates as passive loopback, will retransmit any received data on the Rx line and then send these data onto the Tx line. These two modes will form a logical loop and help to verify the integrity of data transmitted over the communication link.

4.3.4 Port Status

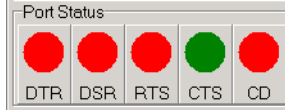

DTR (data-terminal-ready)

DSR (data-set-ready)

RTS (request-to-send)

CTS (clear-to-send)

CD (carrier-detect)

For RS-232 specifications, DTR and RTS are for output signals and can be toggled on and off by double-clicking the labels (such as DTR, DSR, RTS, CTS, CD) under the red/green marks. However, if you are using RTS/CTS for flow control to run the test, you will see the RTS mark appear in black. This indicates that the RTS can no longer be toggled on/off since it is controlled by driver itself.



A black mark represents that the function is controlled by the driver itself and therefore not controllable by software.

4.3.5 Message Logo

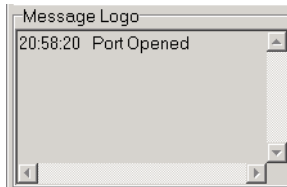

On the **Message Logo** area, you can see the relevant messages about the port(s) you have selected.

For information about specific messages in this area, please refer to Section 4.5, Messages on the Status Bar and Message Logo area.

4.3.6 Tx Slide Bar

The **Tx Slide Bar** allows you to control the overall system loading. You can adjust the transmission rate of your port(s) from 0% to 100%. Just drag the slide button along the track to adjust the transmission rate.



4.3.7 Performance Listing Area

On the performance listing area, you can see the relevant information, such as Rx Length (received packet byte length), Bytes/Sec (transmission rate) and Last Abnormal Status of each port running a test.

Port	Rx Length	(Bytes/Sec.)	Last Abnormal Status
3	0	0	21:54:56 Port Running
4	0	0	21:55:04 Port Running
5	0	0	21:55:04 Port Running
6	0	0	21:55:04 Port Running

4.3.8 Status Bar



The Status Bar is where you can glimpse the current information of the port you have selected. The Status Bar indicates whether the port is READY, RUNNING, BUSY or STOPPED, N/A PORT and the configuration information such as baud rate, data bit, stop bit, parity bit and flow control (represented as 1200 N 8 1 None) settings. Also we can see the duration of the test in hh:mm:ss format on the right.

For information about specific messages on this area, please refer to Section 4.5, Messages on the Status Bar and Message Logo area.

4.4 Using the ICOM Tools Utility

To launch the ICOM Tools testing utility, access Start/Program/Advantech Automation/ICOM/ICOM Tools to start the COM port examine tool.

4.4.1 Port Selection

Please follow the steps below to make your port selection:

1. Launch ICOM Tools. You will first see the Program Window such as Figure 4.1. Since you haven't selected any port for testing yet, all you can see now is a blank window area.



Figure 4.1: ICOM Tools program window

2. Select the port(s) you want to test by the Port/Select menu command or by clicking the Port Select button on the Toolbar, and a dialog box such as Fig. 2 will appear.

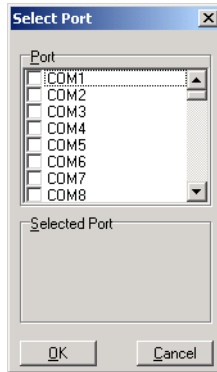

Figure 4.2: Select Port dialog box

Select the port(s) you want to perform test on from the checkboxes next to each COM port. You can either click the checkbox or double-click the name(s) of the port(s) to select/deselect port(s) to perform the test on. The port(s) you selected will immediately appear in the Selected Port field.

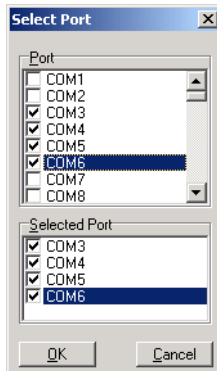

Figure 4.3: Ports You Select Will Appear in the Selected Port Checkbox Group

Click OK to bring up the ICOM Tools User Interface such as below:

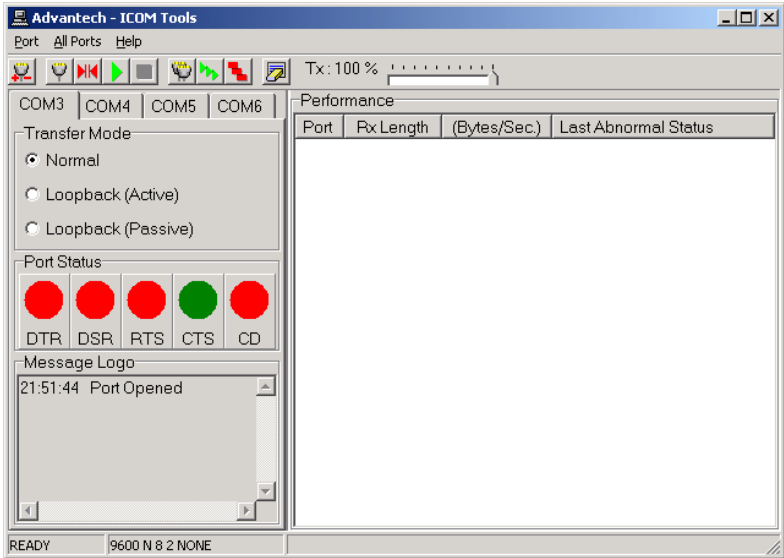

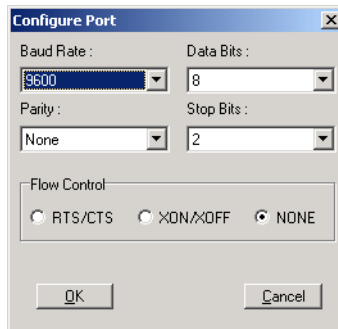



Figure 4.4: ICOM Tools User Interface

4.4.2 Configuring a Port



You can choose to configure a specific port (or to configure all ports) before running your test. Just click a Com Port Tab to select the port you want to configure, and then click the **Port Setup**  button or use the **Port/Setup** menu command (or if you want to configure all ports at once, just click the **All Ports Setup**  button or access the **All Ports/Setup** menu command) to bring up the **Configure Port** dialog box such as below.



In the **Configure Port** dialog box, you can configure the Baud Rate, Data bits, Parity, Stop Bits and the flow control mode for that specific port (or for all ports). After you have configured all the settings you want to change, click OK to make this configuration active.

NOTE: *When using **All Ports Setup** button or **All Ports/Setup**  menu command to configure settings for all ports, you must take care to stop any ports that are running test in order to configure them. If you do not stop the test running on a specific port, it won't be configured at all. That is, you get to configure only the ports that have been stopped.*

Run the Test

After you have completed the configuration of the port(s), you can now start the test on the port you have selected by clicking the **Run**  button or accessing the **Port/Run** menu command (or you want to run all ports at once, just click the **All Ports Run**  button or access **All Ports/Run** menu command).

Once the test is started, you can see relevant test information of port performance on the **performance listing area**.

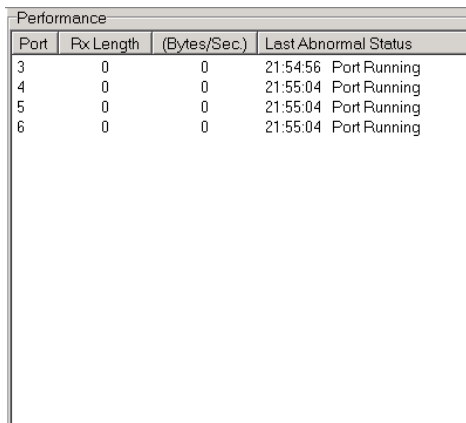

The screenshot shows a window titled "Performance" containing a table with the following data:



Port	Fx Length	(Bytes/Sec.)	Last Abnormal Status
3	0	0	21:54:56 Port Running
4	0	0	21:55:04 Port Running
5	0	0	21:55:04 Port Running
6	0	0	21:55:04 Port Running



Figure 4.5: Test Information on the Performance Listing Area

The Performance Listing Area

<i>Port</i>	The com port number
<i>Rx length</i>	Received packet length in bytes
<i>Bytes/Sec</i>	Transmission rate in Bytes/Sec
<i>Last Abnormal Status</i>	Last abnormal status

Stop the Test

If you want to stop the test on a specific port, just click **Port Stop**  button or access **Port/Stop** menu command (or if you want to stop test on all ports, just click **All Ports Stop**  button or access All Ports/Stop menu command).

You can restart the test by clicking the **Run**  button or accessing the Port/Run menu command (or if you want to run all ports at once, just click the **All Ports Run**  button or access All Ports/Run menu command).

4.4.3 Close Port

If you want to close a port, just select the **Com Port** tab and click **Port Close** button or access **Port/Close** menu command to close the port.

4.4.4 Exit the ICOM Tools utility

To exit the ICOM Tools utility, simply access Port/Exit menu command or click the Close button on the upper right corner of the program window.

4.5 Messages on Status Bar and Message Logo Area

Messages appearing on the Status Bar and Message Logo area are helpful in understanding specific information of your system settings and performance.

4.5.1 Status Bar Messages

BUSY: the port is currently used by another application.

FAIL: the configuration parameters are not accepted by the port

N/A PORT: the port is not available in the system

READY: the port is ready to run or to be configured.

RUNNING: the test is running on the port

STOPPED: the test running on the port has been stopped by the user

4.5.2 Message Logo Messages

Port Opened: The user has opened the port

Port Setup Fail: The user has set up the port configuration with parameters that are either incorrect or unsupported.

Port Running: The port is running a test

Port Stopped: The test is stopped on the port

Tx Starting/Tx Stopped: transmitting starting/transmitting stop

Rx Starting/Rx Stopped : receiving starting/receiving stop

Break Error: a break event has been detected on the port

Framing Error: A timing error (i.e. from start bit to stop bit) has been detected on the port

Port I/O Error: An incorrect I/O event has been detected on the port

Rx Overrun: Received data has been overwritten before being processed

Rx Buffer Full Error: The buffer on the receiving end is saturated so that newly arrived data are ignored

Tx Buffer Full Error: The buffer on the transmitting end is saturated so that the data transmitted by applications are ignored.

LB Error - %d: data error is detected in loop back

LB Rx Pending: Loop back mode is waiting for incoming data

Data Setup Error: parameter error in port configuration

Pin Assignments and Wiring

This chapter shows all pin assignments, wiring and the setup of termination resistors.

Sections include:

- Pin Assignments
- Wiring
- Terminator Resistor Setup

Chapter 5 Pin Assignments and Wiring

5.1 Pin Assignments

5.1.1 PCL-740 and PCL-741

The following figures show the pin assignments for the card's DB-9 and DB-25 connectors in RS-232/422/485 and current-loop modes.

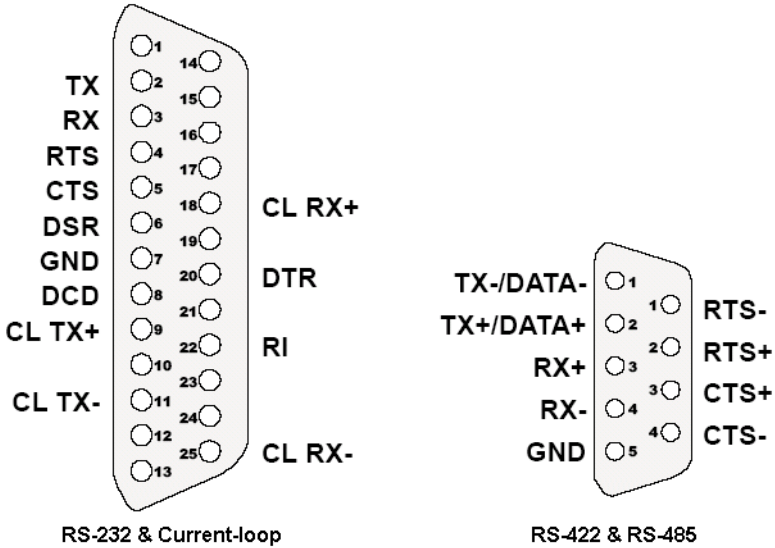

Figure 5.1: PCL-740 Pin Assignments

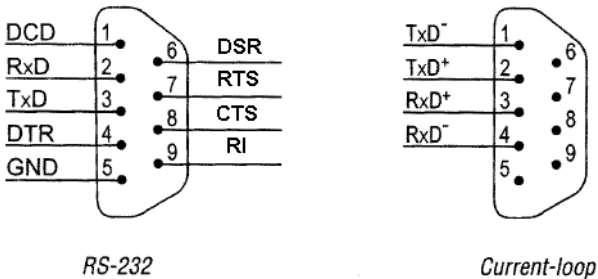

Figure 5.2: PCL-741 Pin Assignments

5.1.2 PCL-743B/S, PCL-745B/S, and PCL-846A/B

The following table show the pin assignments for the card's DB-9 connectors in RS-422 and RS-485 modes.

Table 5.1: PCL-743B/S, PCL-745B/S Pin Description (DB-9 male)

1	TX-(DATA-) or send data - (DTE)	
2	TX+(DATA+) or send data + (DTE)	
3	RX+ or receive data + (DTE)	
4	RX - or receive data - (DTE)	
5	GROUND	
6	RTS - or ready to send -	
7	RTS+ or ready to send +	
8	CTS+ or clear to send +	
9	CTS- or clear to send -	

5.1.3 PCL-746+ and PCL-849A/B/+/L

The following diagrams show the pin assignments for DB-37, DB-25 and DB-9 connectors for RS-232, RS-422 and RS-485 Modes.

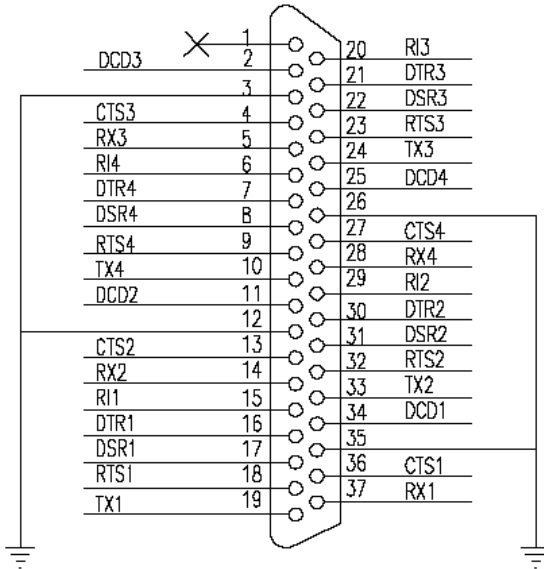

Figure 5.3: PCL-746+, PCL849A/B/+/L RS-232 DB-37 Pin Assignments

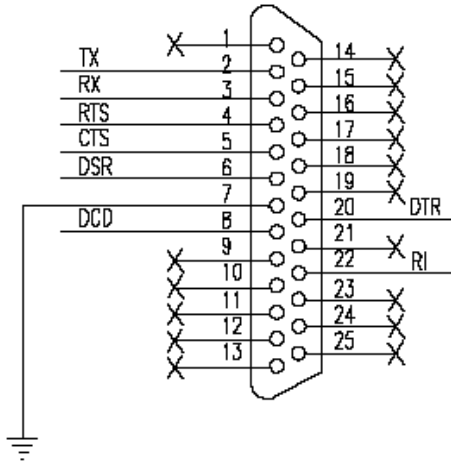

Figure 5.4: PCL-746+, PCL849A/B+/L RS-232 DB-25 Pin Assignments

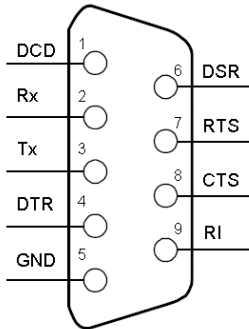

Figure 5.5: PCL-746+, PCL849A/B+/L RS-232 DB-9 Pin Assignments

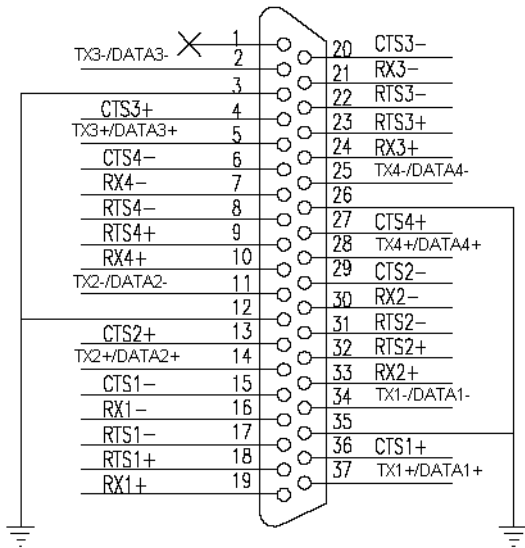

Figure 5.6: PCL-746+ RS-422/RS-485 DB-37 Pin Assignments

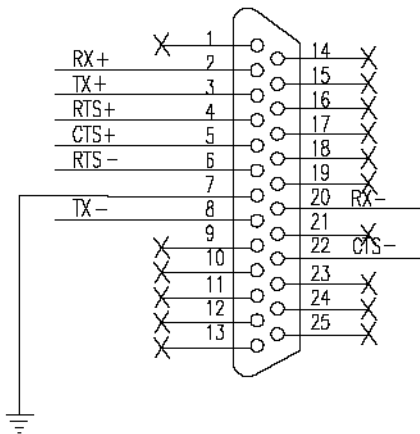

Figure 5.7: PCL-746+ RS-422 DB-25 Pin Assignments

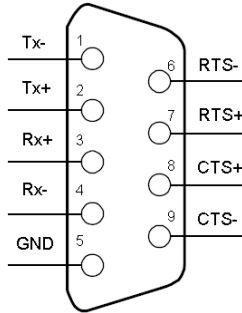

Figure 5.8: PCL-746+ RS-422 DB-9 Pin Assignments

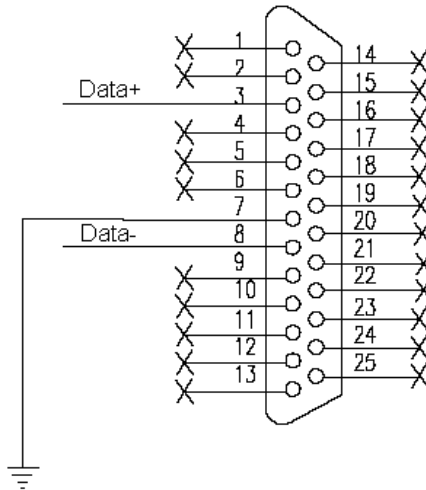

Figure 5.9: PCL-746+ RS-485 DB-25 Pin Assignments

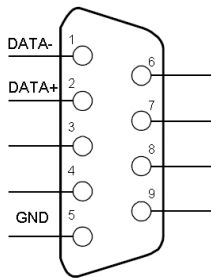

Figure 5.10: PCL-746+ RS-485 DB-9 Pin Assignments

5.1.4 PCL-858A/B

RS-232 8-port connection boxes/octopus cables designed for PCL-858 are:

- Opt8A+: 8-port DB25 female connection box
- Opt8B+: 8-port DB25 male connection box
- Opt8C: Octopus cable with 8 male RS-232 DB25 ports
- Opt8H: Octopus cable with 8 male RS-232 DB9 ports

The following shows the pin assignments of the DB62 connector on the bracket. You may fabricate octopus cable for 8 x DB25 or 8 x DB9 with these pin-outs.

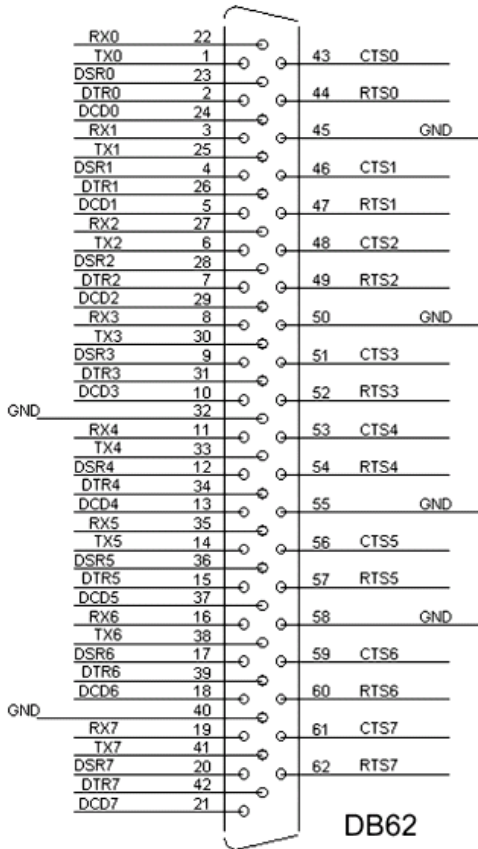

Figure 5.11: PCL-858A/B RS-232 DB-62 Pin Assignments

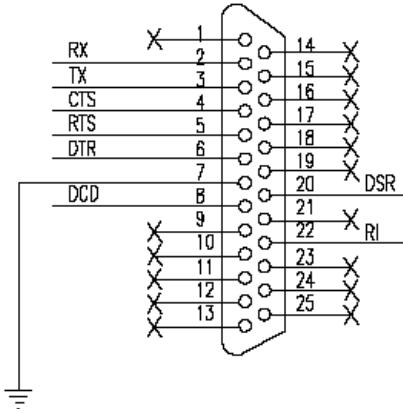

Figure 5.12: PCL-858A/B with OPT8A+ RS-232 DB-25 Pin Assignments

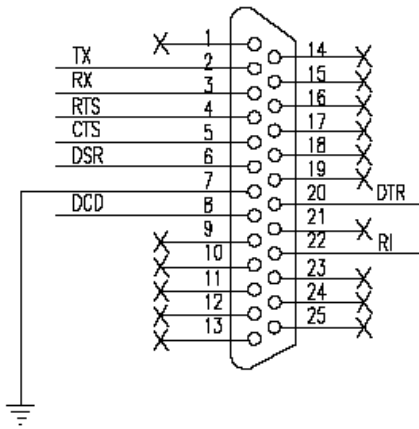

Figure 5.13: PCL-858A/B with OPT8B+/C RS-232 DB-25 Pin Assignments

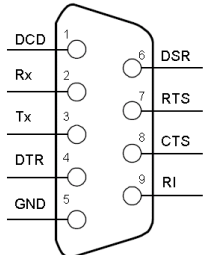

Figure 5.14: PCL-858A/B with OPT8H RS-232 DB-9 Pin Assignments

5.2 Wiring

5.2.1 RS-232 Signal Wiring

Since the RS-232 interface is not strictly defined, many devices have their own connection methods, which may ignore some signal lines or define reserved lines for other functions. It is best to refer to the user's manual of your device for installation instructions. You may find the following helpful.

In general, DTE (Data Terminal Equipment) refers to the device that is leading the communication. Examples include PCs, terminals and some printers. DCE refers to the device being communicated with or controlled. Examples include modems, DSUs (digital service units), printers and lab/factory equipment.

In some situations you may be able to get by with just three lines: data on TXD, RxD, and a signal ground.

Table 5.2: Terminal or PC (DTE) connections

DB-25 Male		DB-25 Male or Female: Terminal	
Pin	Signal	Pin	Signal
2	TxD	3	RxD
3	RxD	2	TxD
4	RTS	5	CTS
5	CTS	4	RTS
6	DSR	20	DTR
7	GND	7	GND
20	DTR	6	DSR
8	DCD	8	DCD

For DTE to DCE connections, use straight through cable (i.e., you don't have to reverse lines 2 and 3, lines 4 and 5, and lines 6 and 20 since, in general, the DCE RS-232 interfaces are reversed themselves).

Table 5.3: Modem Connections

DB-25 Male		Modem (DCE)	
Pin	Signal	Pin	Signal
2	TxD	2	RxD
3	RxD	3	TxD
4	RTS	4	CTS
5	CTS	5	RTS
6	DSR	6	DTR
7	GND	7	GND
20	DTR	20	DSR
8	DCD	8	DCD

Therefore, if you are not using CTS, RTS, DSR ,DTR and DCD signals, please short pins 4 and 5 together, and please short pins 6, 8,and 20 together.

Table 5.4: Terminal without Handshake

DB-25 Male		Terminal, PC (DTE)	
Pin	Signal	Pin	Signal
2	TxD	3	RxD
3	RxD	2	TxD
4 5	RTS — CTS —		
7	GND	7	GND
6 20 8	DSR — DTR — DCD —		

5.2.2 RS-422 Signal Wiring

The RS-422 interface wiring is based on one-to-one principles. The transmit lines on one side connect to the receive lines on the other side, and vice versa. With RS-422, you can transmit and receive data simultaneously (full duplex). The connections are as follows:

Table 5.5: PCL-743B/S, PCL-745B/S RS-422 Wiring Table

DTE (Male DB-9)		Terminal DTE
Pin	Signal	Signal
1	TxD-	RxD-
2	TxD+	RxD+
3	RxD+	TxD+
4	RxD-	TxD-
5	GND	GND
6	RTS-	CTS-
7	RTS+	CTS+
8	CTS+	RTS+
9	CTS-	RTS-

The signals DSR, DTR and DCD are shorted internally on the cards when operating in RS-422 mode.

Terminator Resistors Setup

A user can solder in termination resistors if necessary for impedance matching. The card has two jumpers for termination resistors, but no resistors are installed at the factory. Resistors are usually installed at both ends of the communication lines. The value of each resistor should equal the characteristic impedance of the signal wires used (approximately 120 Ohms or 300 Ohms). The following table shows every card's terminator resistor.

Item	Port 1	Port 2	Port 3	Port 4
PCL-740	TR1, TR2			
PCL-743S/B PCL-745S/B	TR1, TR2, TR5, TR6	TR3, TR4, TR7, TR8		
PCL-746+	TR1, TR8	TR2, TR5	TR3, TR6	TR4, TR7
PCL-846A/B	TR1 ~ TR4	TR5 ~ TR8	TR9 ~ TR12	TR13 ~ TR16

5.2.3 RS-485 Signal Wiring

The RS-485 standard supports half-duplex communication. This means that just two wires are needed to both transmit and receive data. Handshaking signals (such as RTS, Request To Send) are normally used to control the direction of the data flow and to switch the transmission accordingly. In RS-485 mode, the communication card automatically senses the direction of the data flow and switches the transmission direction — no handshaking is necessary. This means a user can build an RS-485 network with just two wires. This RS-485 control is completely transparent to the user. The software written for half duplex RS-232 works without the need for any modification.

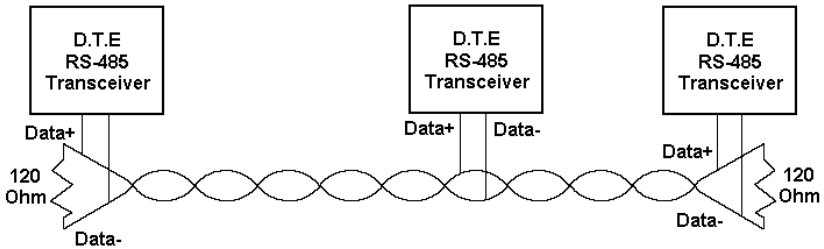

Figure 5.15: RS-485 Wiring Topology

5.3 Terminator Resistor Setup

You can install termination resistors if necessary for impedance matching. The card has jumpers for termination resistors, but no resistors are installed at the factory. Depending on your application you may need to solder in a single resistor to handle the DATA+/ DATA- pair (and a corresponding resistor on the other end of the connection). The value of the resistor should equal the characteristic impedance of the signal wires (approximately 120 or 300 Ohms). The following table shows every card's terminator resistor.

Item	Port 1	Port 2	Port 3	Port 4
PCL-740	TR1			
PCL-743S/B PCL-745S/B	TR1	TR3		
PCL-746+	TR1	TR2	TR3	TR4
PCL-846A/B	TR1	TR5	TR9	TR13