

ADAM-4510 RS-422/RS-485 Repeater

ADAM-4510S Isolated RS-422/485 Repeater

ADAM-4520 Isolated RS-422/485 Converter

Startup Manual

Packing List

Before you begin installing your module, please make sure that the following materials have been shipped:

- 1 x ADAM-4510, ADAM-4510S or 4520
- 1 x DIN-rail mounting bracket (attached to module)
- 1 x ADAM-4510/4510S/4520 Startup Manual
- 1 x Panel mounting bracket

If any of these items are missing or damaged, contact your distributor or sales representative immediately.

Manual and Software

For detailed information about the ADAM-4510, ADAM-4510S or ADAM-4520, please refer to the manual on the enclosed CD (in PDF format).
CD:\Manual\ADAM 4000\ADAM-4000.pdf

Note : Acrobat Reader is required to view any PDF file.
Acrobat Reader can be downloaded at: <http://www.adobe.com/products/acrobat/readstep2.html>
(Acrobat is a trademark of Adobe.)

A software utility and user manual can be found on the driver CD: CD:\ADAM-4000-5000\ADAM_Utility.exe

CE/FCC Notification

ADAM-4510, ADAM-4510S and ADAM-4520 developed by Advantech Co., Ltd. has passed the CE and FCC test for environmental specifications. The test conditions for passing including the equipment being operated within an industrial enclosure. Therefore, in order to protect the ADAM module from being damaged by ESD, we strongly recommend that the use of CE-compliant industrial enclosure products

For more information on this and other Advantech products, please visit our website

This manual is for ADAM-4510, ADAM-4510S and ADAM-4520.

Part No. 2003451000

4th Edition
March 2005.

Overview

Most industrial computer systems come with RS-232 serial ports. Though widely accepted, RS-232 has limited transmission speed, range and networking capabilities. The RS-422 and RS-485 standards overcome these limitations by using differential voltage lines for data and control signals.

ADAM-4520 is a isolated converter for systems originally equipped with RS-232. It transparently converts RS-232 signals into isolated RS-422 or RS-485 signals. You don't need to change your PC's hardware or your software. The ADAM-4520 lets you easily build an industrial grade, long distance communication system with standard PC hardware.

The ADAM-4510 and ADAM-4510S repeaters simply amplify, or boost, existing RS-485 signals to enable them to cover longer distances. They extend the communication distance by 4000 ft (1200 m) or extends the number of connected nodes by 32.

Intelligent RS-485 Control

The RS-485 standard supports half-duplex communication. This means that just two wires are needed to both transmit and receive data. Handshaking signals (such as RTS, Request To Send) are normally used to control the direction of the data flow. A special I/O circuit in ADAM-4510, ADAM-4510S, and ADAM-4520 automatically senses the direction of the data flow and switches the transmission direction. No handshaking signals are necessary. So you can build an RS-485 network with just two wires. This RS-485 control is completely transparent to the user. Software written for half-duplex RS-232 works without modification.

Isolation (ADAM-4510S/4520 only)

ADAM-4510S and ADAM-4520's Opto-isolators provide 3000 V_{DC} isolation to protect the host computer from ground loops and destructive voltage spikes on the RS-485 data lines.

Surge Protection (RS-485 only)

ADAM-4510/4510S and ADAM-4520 offer internal surge-protection on their data lines. Internal high speed transient suppressors on each data line protect the modules from dangerous voltages levels or spikes.

Tough Industrial Design

You can power ADAM-4510, ADAM-4510S and ADAM-4520 with any unregulated power source between +10 and +30 V_{DC} . Their industrial-grade plastic shells can be mounted on a DIN-rail, panel or in a piggybacked stack. You make signal connections through plug-in screw terminal blocks, guaranteeing easy installation, maintenance and modification

Features

- Automatic internal RS-485 bus supervision
- No external flow control signals required for RS-485
- Minimum 3000 V_{DC} isolation (ADAM-4510S/4520)
- Transient suppression on RS-485 data lines
- Baudrate up to 115.2 kbps
- Networking up to 4000 feet
- Reserved space for termination resistors
- Power and data flow indicator for troubleshooting
- Power requirement: +10 to +30 V_{DC}
- Mounts easily on DIN-rail or panel

Specifications

Common

- **Power Requirement:**
Unregulated +10 to +30 V_{DC} with protection from power reversals
- **Case:** ABS with captive mounting hardware
- **Accessories (Supplied):**
DIN-rail Mounting Adapter
Panel Mounting Bracket
- **Plug-in screw terminal wiring:**
Accepts AWG 1-#12 to #22 (0.5 to 2.5 mm) wires
- **Operating Temperature:** -10 ~ 70° C (14 ~ 158° F)
- **Storage Temperature:** -25 ~ 85° C (13 ~ 185° F)
- **Humidity:** 5 ~ 95%, non-condensing

ADAM-4510/4510S Specifications

- **Baudrate (bps):** 1200, 2400, 4800, 9600, 19.2 k, 38.4 k, 57.6 k, 115.2 k, RS-422 (switchable)
- **Isolation Voltage:** 3000 V_{DC} (4510S only)
- **RS-422/RS-485 interface connector:** plug-in screw terminal
- **Power Consumption:** 1.4 W

ADAM-4520 Specifications

- **Baudrate (bps):** 1200, 2400, 4800, 9600, 19.2 k, 38.4 k, 57.6 k, 115.2 k, RTS control and RS-422 mode (switchable)
- **Isolation Voltage:** 3000 V_{DC}
- **RS-232 Interface Connector:** Female DB-9
- **RS-422/RS-485 Interface Connector:** plug-in screw terminal
- **Power Consumption:** 1.2 W

Switch Settings

Switch Descriptions

DIP switches in the ADAM converter and repeater modules set the data format (number of bits) and baudrate for the ADAM network. You can configure the other modules in the network via software commands. Your program and the PC's serial port should match the settings of the converter and repeater modules.

SW1

Switch 1 controls the data format. Data can be 9, 10, 11 or 12 bits. The factory default is 10 bits: one start bit, eight data bits, no parity bit and one stop bit.

When using the converter in combination with other ADAM modules, do not change the default setting as ADAM modules have a fixed data format of ten data bits. The option of changing to 9, 11 or 12 bits is for use with other modules (other than ADAM modules) that have different data formats. Should you change the data format, be aware that you will have to change the data format settings on all the other modules in the network.

SW2





Switch 2 sets the baudrate. The options range from 1200 bps to 115.2 kbps. The factory default is 9600 bps. Be aware that when you change the baudrate, you have to change the baudrate for all the connected modules accordingly. If the RS-422 mode is ON, the baudrate doesn't need to be set.

Default Settings

Both Modules are not addressable by the host computer, the baud rate and data format must be set using SW1 and SW2 located inside the module. The default settings are:

| Function | Setting |
|-------------|----------|
| Baud rate | 9600 bps |
| Data format | 10 bits |

Data Format Settings (SW1)

| | |
|-------------------|---|
| 9 bits |  |
| 10 bits (default) |  |
| 11 bits |  |
| 12 bits |  |

Baud Rate Settings (SW2)

ADAM-4510/4510S Repeater Module

| | |
|------------|--|
| 1200 bps | |
| 2400 bps | |
| 4800 bps | |
| *9600 bps | |
| 19.2 kbps | |
| 38.4 kbps | |
| 57.6 kbps | |
| 115.2 kbps | |
| RS-422 | |

ADAM-4520 RS-232/RS-485 Converter Module

| | |
|-------------|--|
| RTS Control | |
| 1200 bps | |
| 2400 bps | |
| 4800 bps | |
| *9600 bps | |
| 19.2 kbps | |
| 38.4 kbps | |
| 57.6 kbps | |
| 115.2 kbps | |
| RS-422 | |

There is one LED located on the top panel of ADAM-4510/4510S/4520. Its purpose is to show the communication status.

| Communication status | LED color | |
|----------------------|-----------------|-------|
| RS-485 | idle | Green |
| | RS-232 → RS-485 | Dark |
| | RS-485 → RS-232 | Red |
| RS-422 | idle | Dark |
| | RS-232 → RS-422 | Dark |
| | RS-422 → RS-232 | Red |

Application Wiring

Power Supply

For easy use in industrial environments, the ADAM modules are designed to accept industry standard +24 V_{DC} unregulated power. Operation is guaranteed when using any power supply between +10 and +30 V_{DC}. Power ripples must be limited to 5 V peak to peak while the voltage in all cases must be maintained between +10 and +30 V_{DC}. All power supply specifications are referenced at module connector.

The power cables should be selected according to the number of modules connected and the length of the power lines. When using a network with long cables, we advise the use of thicker wire to limit the line voltage drop. In addition to serious voltage drops, long voltage lines can also cause interference with communication wires.

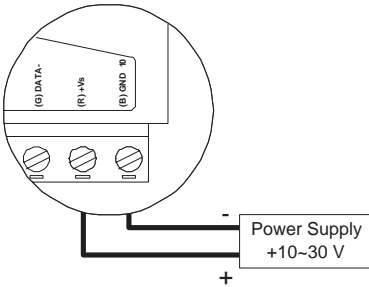

We advise that the following standard colors (as indicated on the modules) be used for power lines:

- +Vs (R) Red
- GND (B) Black

Communication Wiring

We recommend that shielded-twisted-pair cables that comply with the EIA RS-485 standard be used with the ADAM network to reduce interference. Only one set of twisted-pair cables is required to transmit both data and RTS signals. We advise that the following standard colors (as indicated on the modules) be used for the communication lines:

- DATA + (Y) Yellow
- DATA - (G) Green

Basic configuration hook-up.

Before placing a module in an existing network, the module should be properly configured. The two following diagrams show typical layouts for both modules.

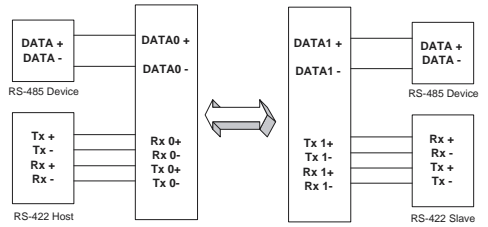
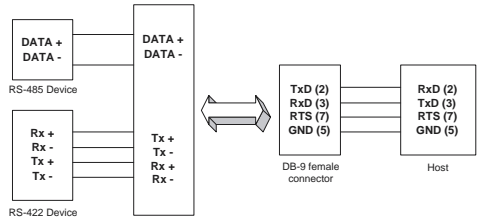

ADAM Dimensions

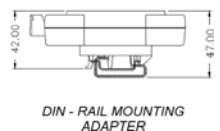
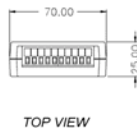
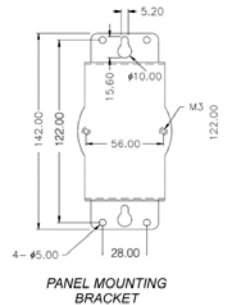
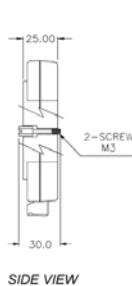
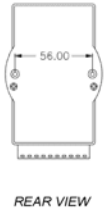
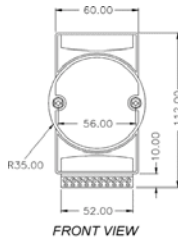

Function Diagrams

ADAM-4510 Repeater

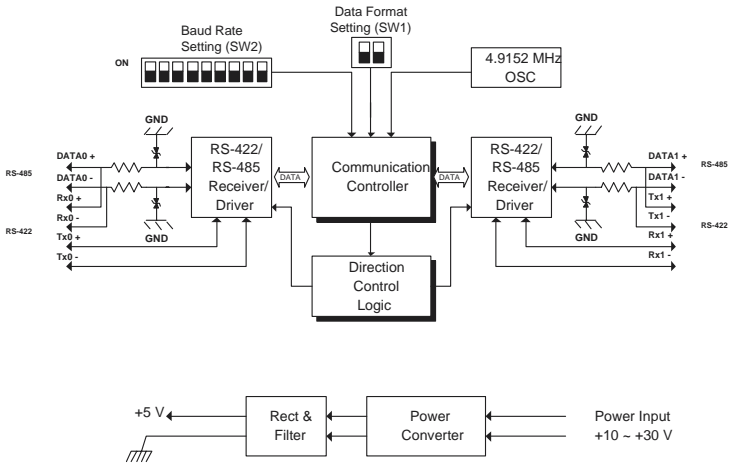

ADAM-4510S Repeater

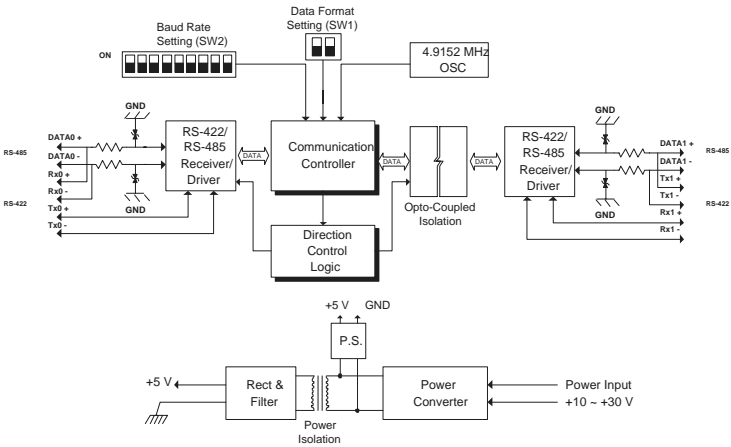

ADAM-4520 Converter

