

# **EXDUL-336E**

**EDP No.: A-385340**

# **EXDUL-336S**

**EDP No.: A-385320**

Firmware Version 4.05  
Rev. 2

10 optocoupler isolated digital inputs  
8 relay outputs  
2 16bit counters  
LCD display (EXDUL-336E only)

**wasco<sup>®</sup>**

user's guide

## Copyright© 2015 by Messcomp Datentechnik GmbH

This documentation is protected by copyright of Messcomp Datentechnik GmbH. All rights are reserved.

Messcomp Datentechnik GmbH reserves the right to modify the products described in this manual at any time and without announcement.

No part of this manual is allowed to be reproduced, copied, translated or transmitted in any way without the prior written consent of Messcomp Datentechnik GmbH.

## Registered Trademarks

Windows®, Visual Basic®, Visual C++®, Visual C#® are registered trademarks of Microsoft.

Delphi® is registered trademark of Borland.

**wasco**® is registered trademark.

EXDUL® is registered trademark.

## Disclaimer

The information in this manual is intended to be accurate and reliable. The company Messcomp Datentechnik GmbH assumes no liability for the use of the multi functional module EXDUL-336 and this documentation, neither for direct nor indirect damages.

## Important Information:

This manual was written for the modules EXDUL-336E and EXDUL-336S. EXDUL-336E additionally provides an LCD display, all other functions are identical. For EXDUL-336S all commands and functions concerning the LCD display are not applicable.

## Table of Contents

<b>1. Description</b> .....	<b>5</b>
<b>2. Connection Terminals</b> .....	<b>6</b>
2.1 Terminal Assignment of CN1 .....	6
<b>3. System Components</b> .....	<b>7</b>
3.1 Block Diagram EXDUL-336E.....	7
3.2 Block Diagram EXDUL-336S.....	8
3.3 Optocoupler Inputs .....	9
3.4 Relay Outputs.....	9
3.5 Digital Counters .....	9
3.6 LCD Display (EXDUL-336E only) .....	9
<b>4. Initial Start-up</b> .....	<b>10</b>
4.1 Connection via USB Port.....	10
4.2 Power Supply via USB Port.....	10
4.3 Power Supply via an External Voltage Source .....	10
4.4 LCD Display while Booting (EXDUL-336E only).....	10
4.5 LCD Display while in Operation (EXDUL-336E only) .....	11
<b>5. Installing the Windows<sup>®</sup> Drivers</b> .....	<b>12</b>
<b>6. Programming on Windows<sup>®</sup></b> .....	<b>13</b>
6.1 Overview.....	13
6.2 Communication with EXDUL-336.....	13
6.3 Windows <sup>®</sup> Functions for Programming .....	14
6.4 Command and Data Format .....	14
6.5 Register Config, HW Identification and Serial Number.....	15
6.6 Memory Areas UserA, UserB, UserLCD1m* and UserLCD2m* .....	16
6.7 Display Register UserLCD-Line1*, UserLCD-Line2* and LCD Contrast* .....	16
6.8 Index of Commands .....	17
6.9 Structure of Commands.....	19
<b>7. Specifications</b> .....	<b>36</b>

\* (EXDUL-336E only)

**Table of Contents**

**8. Examples for circuitry**.....38  
    8.1 Wiring of the Inputs.....38  
    8.2 Wiring of the Outputs.....39

**9. ASCII Table**.....41

**10. Release Notes**.....44

**11. Product Liability Act**.....45

**12. CE Declaration of Conformity** .....47

## 1. Description

























The data acquisition modules EXDUL-336E and EXDUL-336S feature ten digital inputs and eight digital outputs each of which are galvanically isolated. Electrical isolation at inputs is made by top-quality optocouplers with integrated Schmitt trigger function. Electrical isolation at the outputs is made by special high power relays managing a switching current of 2 A. Two of the ten optocoupler inputs are programmable and usable as digital counters if required. EXDUL-336E additionally provides an LCD display which can display I/O status information or user specific data.

Connecting to a computer is made quickly and conveniently Plug & Play via a USB interface. The required power supply can be provided via USB port or by an external voltage source

The module has a 24-pin screw terminal for connection of the input optocouplers and output relays and external power supply. The compact chassis enables the module to be used as a portable device with a notebook. For mechanical engineering control applications it can also easily be attached to a DIN mounting rail.

## 2. Connection Terminals

### 2.1 Terminal Assignment of CN1

OUT01A	2 	 1	OUT00A
OUT03A	4 	 3	OUT02A
OUT05A	6 	 5	OUT04A
OUT07A	8 	 7	OUT06A
NC	10 	 9	OUT00...07B
IN01+	12 	 11	IN00+ / Counter1
IN03+	14 	 13	IN02+
IN05+	16 	 15	IN04+ / Counter2
IN07+	18 	 17	IN06+
IN09+	20 	 19	IN08+
NC	22 	 21	IN00...09-
GND_EXT	24 	 23	Vcc_EXT

**Vcc\_EXT:**

Connector for external voltage source

**GND\_EXT:**

Ground connection when using external voltage source

**NC:**

Not connected

# 3. System Components

## 3.1 Block Diagram EXDUL-336E

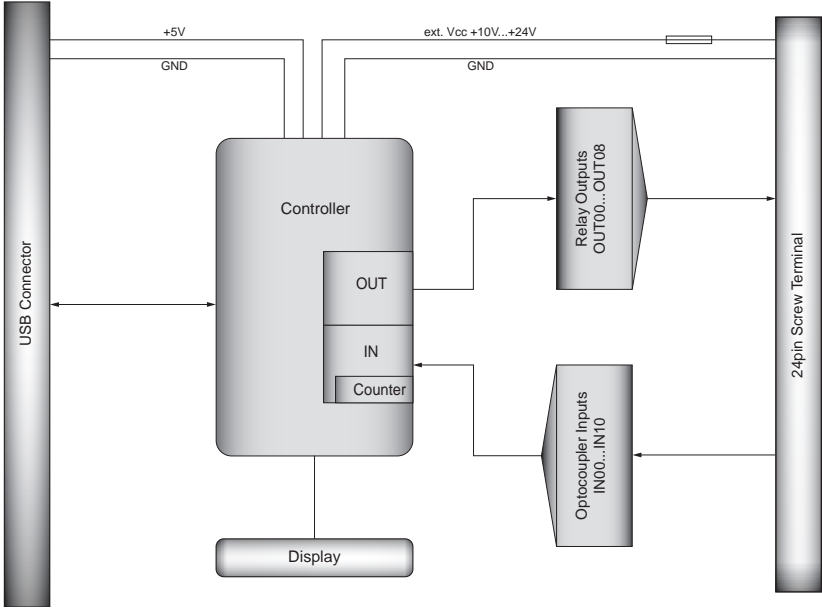

### 3.2 Block Diagram EXDUL-336S

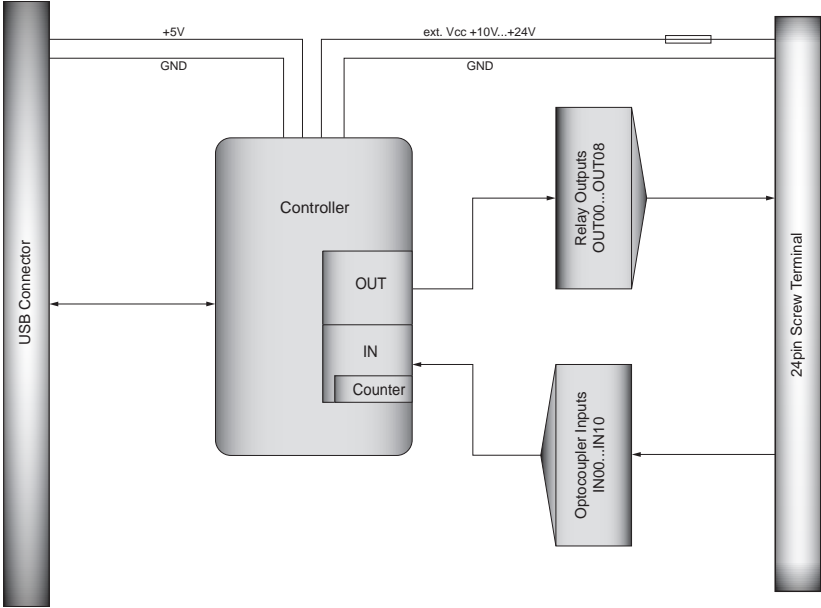



### **3.3 Optocoupler Inputs**

10 channels, galvanically isolated

Common ground connection (cathodes connected)

Two of the channels programmable to be digital counters

Optocouplers with integrated Schmitt trigger function

Overvoltage protection diodes

Input voltage range: low = 0....3 Volt      high = 10.....30 Volt

Input frequency: max. 10 kHz

### **3.4 Relay Outputs**

8 channels galvanically isolated

Relay contact A : one terminal connection each

Relay contact B: common terminal connection

Contact: 1 NO contact

Contact current rating: max. 2 A

Contact voltage rating: max. 30 VAC / 30 VDC

Contact power rating: max. 60 VA / 60 W

Mechanical lifetime: max.  $20 * 10^6$  operating cycles without load

Contact lifetime: 2 A, 30 VAC at NO contact, max.  $10^5$  switching cycles

Operating cycles under load: max. 10/min

Operating cycles without load: max. 1200/min

Circuit time: typ. 5 ms

Release time: typ. 2 ms

Bouncing time NO contact: < 1 ms

### **3.5 Digital Counters**

2 programmable digital 16bit counters

(2 of the 10 optocoupler inputs are assigned)

Counting frequency: max. 5 kHz

### **3.6 LCD Display (EXDUL-336E only)**

Matrix display with 2 lines and 16 columns performing 16 characters each line

Info display while booting

Display of I/O status or UserLCD while in operation

## 4. Initial Start-up

Connecting the EXDUL-336 to a computer is made quickly and conveniently Plug & Play via a USB interface. The required operating voltage for the module can be supplied via the USB port or by an external voltage source.

### 4.1 Connection via USB Port

EXDUL-336E / EXDUL-336S features a USB 2.0 interface and can be connected directly to the computer or via USB hub using the enclosed USB connecting cable. The module is hot-pluggable, this means it is connectable even during running operations of your computer's system.

### 4.2 Power Supply via USB Port

If the USB port is used to power the device, then the operating voltage will be +5V. It may be necessary to configure your operating system software to obtain appropriate power requirements (see section Specifications).

### 4.3 Power Supply via an External Voltage Source

EXDUL-336E / EXDUL-336S firmware will automatically detect when an external voltage source is used. Applying a voltage between +10V and +24 V across Vcc\_EXT and GND\_EXT (see fig. Terminal Configuration), will immediately cause the device to switch to „external“ source. The power supply via USB port will automatically be interrupted.

### 4.4 LCD Display while Booting (EXDUL-336E only)

When you boot the module the LCD display will show an info display with the module name in the first line. Once the booting process is completed, it will show I/O status display or UserLCD display depending upon your settings.

#### 4.5 LCD Display while in Operation (EXDUL-336E only)

Once the booting process is completed the module switches from info display to I/O status or UserLCD display depending upon your setting. If you selected I/O status display, the current input states are shown in line 1, the output states in line 2. If you activated the mode UserLCD display then instead of I/O status the display will show values from memory areas UserLCD1m and UserLCD2m. The data from UserLCD1m and UserLCD2m will be displayed as long as you not write out new user data to the UserLCD line1 or UserLCD line2.

To avoid „screen-burn“ while in operation the display switches from I/O status display or UserLCD display respectively to extended info display (see table below) for about five seconds every minute.

Display	Meaning
EXDUL-336 u c	u = Vcc via USB, c = USB connected
EXDUL-336 e c	e = Vcc external, c = USB connected
EXDUL-336 e n	e = Vcc external, n = USB not connected

## 5. Installing the Windows<sup>®</sup> Drivers

When you connect the USB-module EXDUL-336E / EXDUL-336S to your computer for the first time, Windows<sup>®</sup> will automatically detect a new hardware and search for a suitable driver.

To install the driver indicate the directory and the file „wascoxmfe.inf“ into the Windows Hardware Wizard.

After the driver database has been updated the Hardware Wizard will inform you about the successful installation of the driver.

The Windows<sup>®</sup> Device Manager will now show your USB module EXDUL-336E / EXDUL-336S as a Wasco USB Communication Port COMx in its directory connections (COM/LTP) tree. All Windows<sup>®</sup> software can access to the virtual interface as if it were a real COM port.

## 6. Programming on Windows<sup>®</sup>

### 6.1 Overview

After successful installation the USB module EXDUL-336E / EXDUL-336S is listed as a Wasco USB Communication Port COMx in your Windows<sup>®</sup> Device Manager. This is a CDC device (Communications Device Class), that is addressed via a virtual COM port.

The software access to this virtual COM port operates like a normal COM interface of default Windows<sup>®</sup> drivers, and it is not necessary to install any additional drivers.

### 6.2 Communication with EXDUL-336

Data is exchanged by transmitting and receiving null-terminated strings via the virtual COM interface.

Every transmitting or receiving string consists of 3 elements in ANSI format (1 Byte per character).

Every valid transmission string will be replied by a defined result or confirmation string.

The last result or confirmation string has to be read before transmitting a new string.

### **6.3 Windows<sup>®</sup> Functions for Programming**

You can program EXDUL-336E / EXDUL-336S either via WIN32 API functions or very easily via an already existing serial port object in a programming language. You can find examples in your installation directory on your computer after having installed the software.

Windows<sup>®</sup> functions for programming:

- Create file
- GetCommState
- SetCommState
- WriteFile
- ReadFile
- DCB structure (describes control parameters of the device)

### **6.4 Command and Data Format**

Data is exchanged by transmitting and receiving null-terminated strings. Every transmitting or receiving string consists of 3 elements in ANSI format (1 byte per character).

Configuration and output commands are confirmed by returning the respective string. Reading commands are replied by a string with an operation code and the read value.

## 6.5 Register Config, HW Identification and Serial Number

Byte	0	1	2	3	4	5	6	7	8	9	10	11	12	13	14	15
<b>Config</b>	00	00	01	11	00	0F	FF	FF	FF	FF	FF	FF	FF	FF	FF	FF
<b>HW Identifier</b>	E	X	D	U	L	-	3	3	Ø	V	4	.	0	5		
<b>S/N</b>	1	0	4	4	0	2	6	FF	FF	FF	FF	FF	FF	FF	FF	FF

All settings are stored in the CONFIG register and automatically applied when you restart your computer or when you connect to another computer.

The values arise from CONFIG commands (A2, A3 und A8), the data in CONFIG register remains effective until it is overwritten by CONFIG commands or reset to factory settings (delivery status) by a default reset.

Config Byte	Function
0	reserved
1	State of the outputs at switch on or restart
2	LCD Contrast value (High-Byte)*
3	LCD Contrast value (Low-Byte)*
4	Display mode

The module name is stored in the HW identification register. Here the user can determine the product identity. The hardware identifier ends with a blank (20<sub>hex</sub>). Register SERIAL NUMBER serves for internal purposes and can only be read by the user.

\*: EXDUL-336E only!

## 6.6 Memory Areas UserA, UserB, UserLCD1m\* and UserLCD2m\*

Byte	0	1	2	3	4	5	6	7	8	9	10	11	12	13	14	15
UserA																
	20 <sub>hex</sub>	20 <sub>hex</sub>	20 <sub>hex</sub>	20 <sub>hex</sub>	20 <sub>hex</sub>	20 <sub>hex</sub>	20 <sub>hex</sub>	20 <sub>hex</sub>	20 <sub>hex</sub>	20 <sub>hex</sub>	20 <sub>hex</sub>	20 <sub>hex</sub>	20 <sub>hex</sub>	20 <sub>hex</sub>	20 <sub>hex</sub>	20 <sub>hex</sub>
UserB																
	20 <sub>hex</sub>	20 <sub>hex</sub>	20 <sub>hex</sub>	20 <sub>hex</sub>	20 <sub>hex</sub>	20 <sub>hex</sub>	20 <sub>hex</sub>	20 <sub>hex</sub>	20 <sub>hex</sub>	20 <sub>hex</sub>	20 <sub>hex</sub>	20 <sub>hex</sub>	20 <sub>hex</sub>	20 <sub>hex</sub>	20 <sub>hex</sub>	20 <sub>hex</sub>
UserLCD1m*																
	20 <sub>hex</sub>	20 <sub>hex</sub>	20 <sub>hex</sub>	20 <sub>hex</sub>	20 <sub>hex</sub>	20 <sub>hex</sub>	20 <sub>hex</sub>	20 <sub>hex</sub>	20 <sub>hex</sub>	20 <sub>hex</sub>	20 <sub>hex</sub>	20 <sub>hex</sub>	20 <sub>hex</sub>	20 <sub>hex</sub>	20 <sub>hex</sub>	20 <sub>hex</sub>
UserLCD2m*																
	20 <sub>hex</sub>	20 <sub>hex</sub>	20 <sub>hex</sub>	20 <sub>hex</sub>	20 <sub>hex</sub>	20 <sub>hex</sub>	20 <sub>hex</sub>	20 <sub>hex</sub>	20 <sub>hex</sub>	20 <sub>hex</sub>	20 <sub>hex</sub>	20 <sub>hex</sub>	20 <sub>hex</sub>	20 <sub>hex</sub>	20 <sub>hex</sub>	20 <sub>hex</sub>

In each of the register UserA, UserB, UserLCD1m\* and UserLCD2m\* 16 digits (16 byte) are at your proposal for customizing. The data is retained when you switch off, registers can be set back to factory settings (delivery status) by a default reset. In delivery status in all of the four user memory areas each digit is set to the hex value 20 corresponding to a blank character in ASCII code. The table above shows the hex value and the respective ASCII character.

When the UserLCD mode is activated, the data from the memory registers UserLCD1m\* and UserLCD2m\* will be displayed as long as you not write out new user data to the LCD display via the UserLCD line1 and UserLCD line2

## 6.7 Display Register UserLCD-Line1\*, UserLCD-Line2\* and LCD-Contrast\* (EXDUL-336E only)

When the UserLCD mode is activated you can write any 16 characters into both of the UserLCD-line1 and UserLCD-line2. Once the data are accepted, they are shown on the display instead of the data from UserLCD1m and UserLCD2m. Data from UserLCD-line1 and UserLCD-line2 are **not** retained when switching off. You can adjust the LCD display contrast in the register LCD contrast. This adjustment is also retained stored when the device is switched off.



## 6.8 Index of Commands

Hexcode	Description
D0 03 36	EXDUL-336 Default Reset (restores the delivery settings)
FD xx ww	Writing user area A
FE xx ww	Writing user area B
E0 xx 00	Reading configuration area
EC xx 00	Reading HW identifier
ED xx 00	Reading user area A
EE xx 00	Reading user area B
EF xx 00	Reading serial number
01 03 00	Reading optocoupler input port
02 kk 0x	Reading of single optocoupler inputs
01 13 00	Reading counter1
01 23 00	Reading counter2
81 03 ww	Writing relay output port
82 kk 0x	Writing of single relay outputs
83 kk 0x	Reading of single relay outputs

<b>Hexcode</b>	<b>Description</b>
81 13 00	Start counter1
81 13 FF	Stop counter1
81 23 00	Start counter2
81 23 FF	Stop counter2
A1 03 mm	Writing operation mode byte
A2 03 mm	Writing output port reset value
A3 03 mm	Writing display mode byte*
A8 ww ww	Writing LCD contrast setting value*
AF xy ww	Writing user LCD area*

\*: EXDUL-336E only!

## 6.9 Structure of Commands

### 6.9.1 Writing in User Area A and B

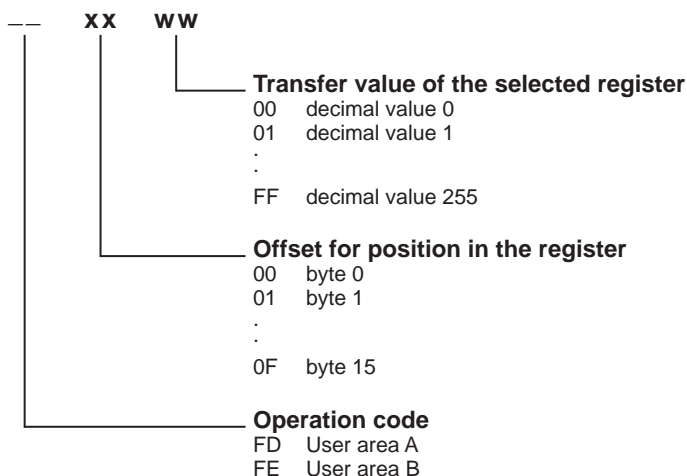

Areas User A and User B each comprise of 16 digits (16 bytes), both areas are written byte by byte.

**For example:** Write the word STEUERUNG in User area A

#### Write

FD<sub>hex</sub> 00<sub>hex</sub> 53<sub>hex</sub>  
 FD<sub>hex</sub> 01<sub>hex</sub> 54<sub>hex</sub>  
 FD<sub>hex</sub> 02<sub>hex</sub> 45<sub>hex</sub>  
 FD<sub>hex</sub> 03<sub>hex</sub> 55<sub>hex</sub>  
 FD<sub>hex</sub> 04<sub>hex</sub> 45<sub>hex</sub>  
 FD<sub>hex</sub> 05<sub>hex</sub> 52<sub>hex</sub>  
 FD<sub>hex</sub> 06<sub>hex</sub> 55<sub>hex</sub>  
 FD<sub>hex</sub> 07<sub>hex</sub> 4E<sub>hex</sub>  
 FD<sub>hex</sub> 08<sub>hex</sub> 47<sub>hex</sub>

#### Return

FD<sub>hex</sub> 00<sub>hex</sub> 53<sub>hex</sub>  
 FD<sub>hex</sub> 01<sub>hex</sub> 54<sub>hex</sub>  
 FD<sub>hex</sub> 02<sub>hex</sub> 45<sub>hex</sub>  
 FD<sub>hex</sub> 03<sub>hex</sub> 55<sub>hex</sub>  
 FD<sub>hex</sub> 04<sub>hex</sub> 45<sub>hex</sub>  
 FD<sub>hex</sub> 05<sub>hex</sub> 52<sub>hex</sub>  
 FD<sub>hex</sub> 06<sub>hex</sub> 55<sub>hex</sub>  
 FD<sub>hex</sub> 07<sub>hex</sub> 4E<sub>hex</sub>  
 FD<sub>hex</sub> 08<sub>hex</sub> 47<sub>hex</sub>

## 6.9.2 Reading Area User A, User B, Serial Number, Configuration Area and HW Identifier

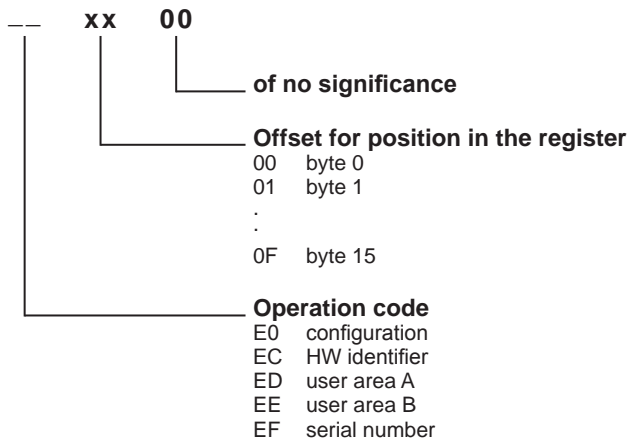

All above-mentioned areas comprise of 16 digits each (16 bytes) and are read byte by byte. Hardware identifier ends with a blank character (20<sub>hex</sub>).

## Adapter Return

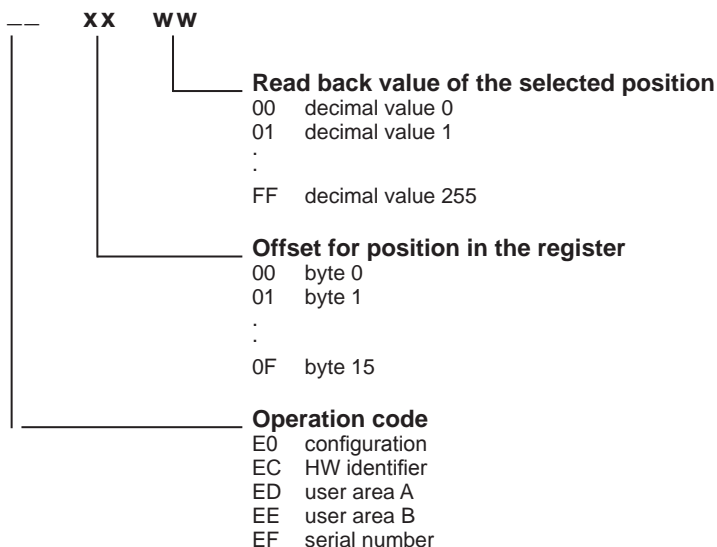

### For Example:

Reading the first 9 digits of the register user area A. The indicated response is valid for the word STEUERUNG (see example in section 6.9.1 Writing in User Area A)

#### Read

ED<sub>hex</sub> 00<sub>hex</sub> 00<sub>hex</sub>  
 ED<sub>hex</sub> 01<sub>hex</sub> 00<sub>hex</sub>  
 ED<sub>hex</sub> 02<sub>hex</sub> 00<sub>hex</sub>  
 ED<sub>hex</sub> 03<sub>hex</sub> 00<sub>hex</sub>  
 ED<sub>hex</sub> 04<sub>hex</sub> 00<sub>hex</sub>  
 ED<sub>hex</sub> 05<sub>hex</sub> 00<sub>hex</sub>  
 ED<sub>hex</sub> 06<sub>hex</sub> 00<sub>hex</sub>  
 ED<sub>hex</sub> 07<sub>hex</sub> 00<sub>hex</sub>  
 ED<sub>hex</sub> 08<sub>hex</sub> 00<sub>hex</sub>

#### Response

ED<sub>hex</sub> 00<sub>hex</sub> 53<sub>hex</sub>  
 ED<sub>hex</sub> 01<sub>hex</sub> 54<sub>hex</sub>  
 ED<sub>hex</sub> 02<sub>hex</sub> 45<sub>hex</sub>  
 ED<sub>hex</sub> 03<sub>hex</sub> 55<sub>hex</sub>  
 ED<sub>hex</sub> 04<sub>hex</sub> 45<sub>hex</sub>  
 ED<sub>hex</sub> 05<sub>hex</sub> 52<sub>hex</sub>  
 ED<sub>hex</sub> 06<sub>hex</sub> 55<sub>hex</sub>  
 ED<sub>hex</sub> 07<sub>hex</sub> 4E<sub>hex</sub>  
 ED<sub>hex</sub> 08<sub>hex</sub> 47<sub>hex</sub>

## 6.9.3 Reading the Optocoupler Inputs

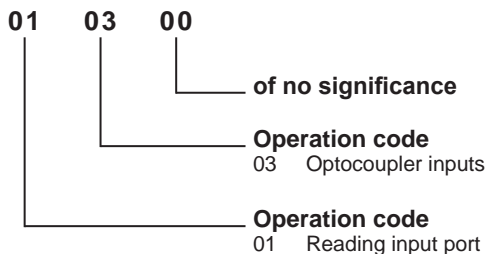

### Adapter response

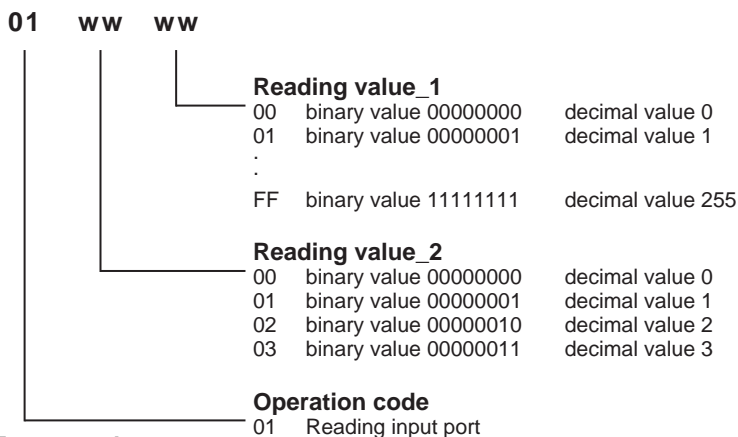

### For example:

Reading inputs from an optocoupler input port. The voltage thresholds for an input to be considered a logic low and logic high are shown below. This example assumes that the correct voltages has been applied to each input optocoupler pin (0 = Low = 0...3 V; 1 = High = 10...30 V)

Input channel	IN09	IN08	IN07	IN06	IN05	IN04	IN03	IN02	IN01	IN00
Terminal screw	20	19	18	17	16	15	14	13	12	11
Input level	1	0	1	1	1	1	0	0	1	1
Display*	E	A	E	E	E	E	A	A	E	E

### Write

01hex 03hex 00hex

### Response

01hex 02hex F3hex

\*: EXDUL-336E only

## 6.9.4 Reading of Single Optocoupler Inputs

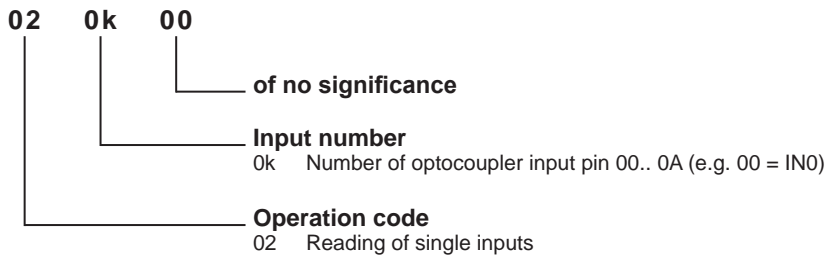

### Adapter Response

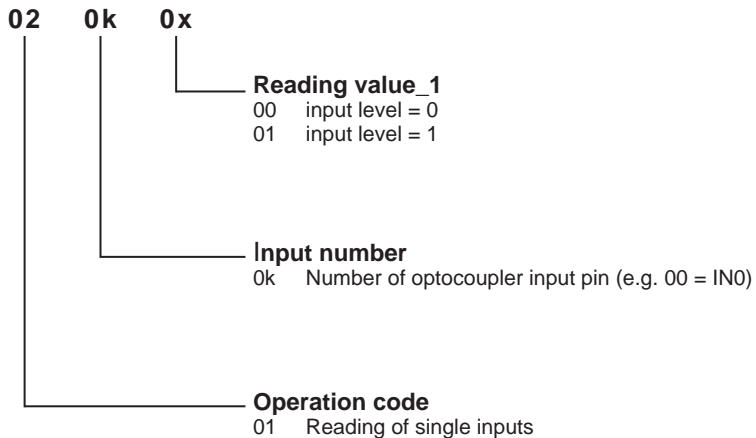

\*: EXDUL-336E only!

### 6.9.5 Writing Relay Output Port

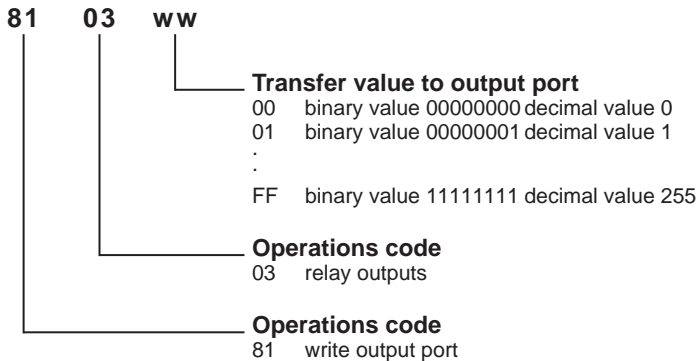

**For example:**

Enable relay OUT02, OUT03, OUT04 und OUT06, relay contacts of the other channels remain made (relay contact made = 1; relay contact broken = 0)

Output channel	OUT07	OUT06	OUT05	OUT04	OUT03	OUT02	OUT01	OUT00
Terminal screw	8	7	6	5	4	3	2	1
Switching status	0	1	0	1	1	1	0	0
Display*	A	E	A	E	E	E	A	A

**Write**

81<sub>hex</sub> 03<sub>hex</sub> 5C<sub>hex</sub>

**Response**

81<sub>hex</sub> 03<sub>hex</sub> 5C<sub>hex</sub>

\*: EXDUL-336E only!



## 6.9.6 Writing of Single Relay Outputs

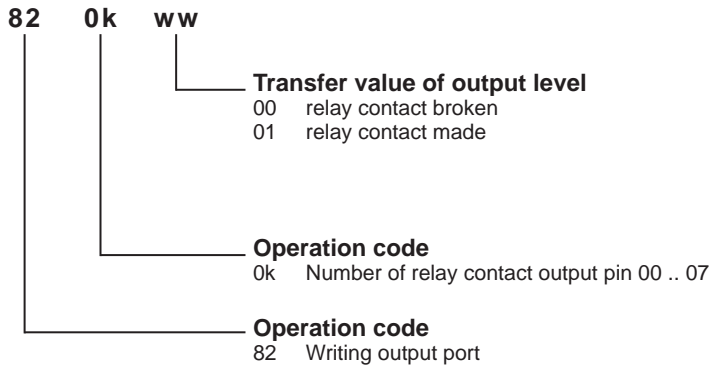

\*: EXDUL-336E only!

### 6.9.7 Reading of Single Relay Outputs

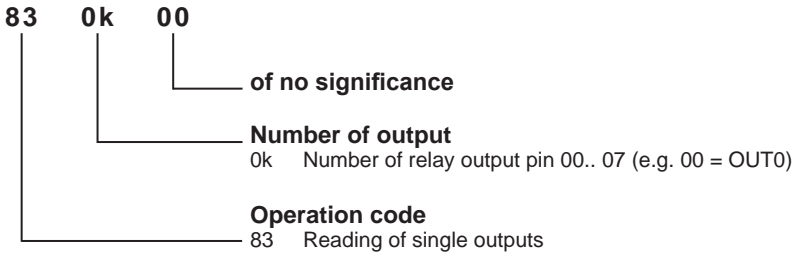

### Adapter Response

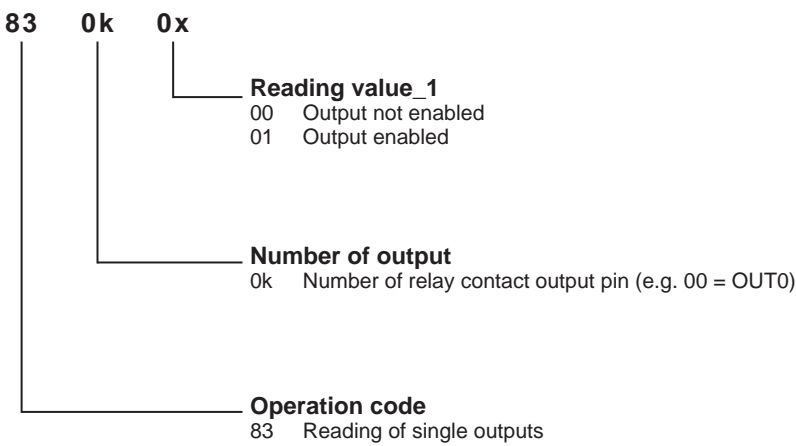

\*: EXDUL-336E only!

### 6.9.8 Writing Operation Mode Byte

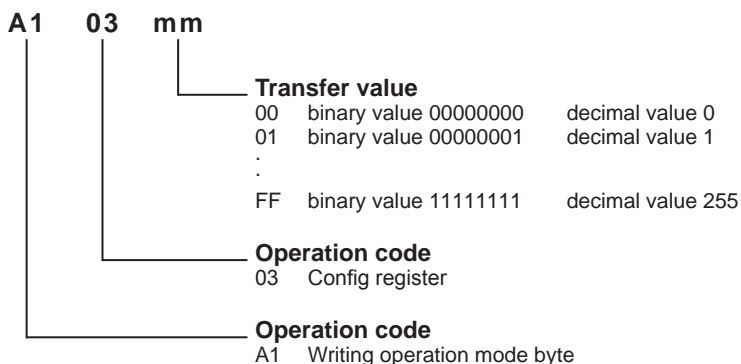

Structure of transfer value:

Bit							Function	
7	6	5	4	3	2	1		0
x	x	1		x	x	x	x	counter2 start at reset
x	x	0		x	x	x	x	counter2 no start at reset
x	x		1	x	x	x	x	counter1 start at reset
x	x		0	x	x	x	x	counter1 no start at reset

Bit 0 to 3 as well as bit 6 and 7 are reserved.

## 6.9.9 Start and Stop the Counters

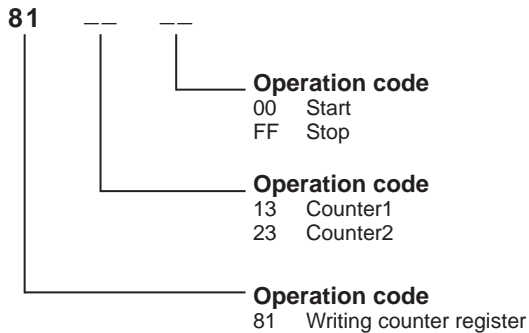

### For example:

Start counter1

#### Write

81<sub>hex</sub> 13<sub>hex</sub> 00<sub>hex</sub>

#### Response

81<sub>hex</sub> 13<sub>hex</sub> 00<sub>hex</sub>

Stop counter2

#### Write

81<sub>hex</sub> 23<sub>hex</sub> FF<sub>hex</sub>

#### Response

81<sub>hex</sub> 23<sub>hex</sub> FF<sub>hex</sub>

Counter1 and counter2 are 16bit counters with a counting range of 0 .... 65535. Every start command will reset the selected counter to 0 and then it will start to count upwards.

## 6.9.10 Reading Counter Value on Counter1 and Counter2

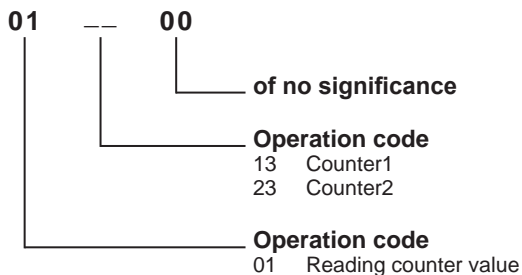

### Adapter Response

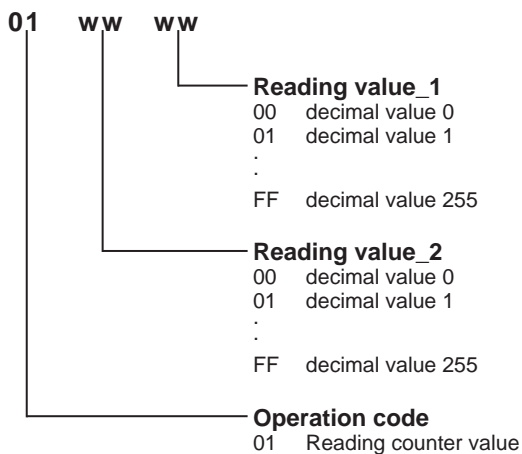

counter value = reading value\_2 x 256 + reading value\_1

### For example:

Reading counter value 2047 on counter1:

**Write**  
01<sub>hex</sub> 13<sub>hex</sub> 00<sub>hex</sub>

**Response**  
01<sub>hex</sub> 07<sub>hex</sub> FF<sub>hex</sub>

**Display\***  
L1: 2047

\*: EXDUL-336E only

Reading counter value 24319 on counter2

<b>Write</b>	<b>Response</b>	<b>Display*</b>
01 <sub>hex</sub> 23 <sub>hex</sub> 00 <sub>hex</sub>	01 <sub>hex</sub> 5E <sub>hex</sub> FF <sub>hex</sub>	L2: 24319

You can read out the current counter value calling a read command at any time and as often as you want to without interrupting the counting process. If the counting range (0 ... 65535) is exceeded, the operation code will response in a modified way (11<sub>hex</sub> instead of 01<sub>hex</sub>). The Display\* will show an „F“ before the count value („Fehlerüberlauf“ - value range exceeded).

**For example:**

Read counter value 2047 on counter2 after the count range being exceeded

<b>Write</b>	<b>Response</b>	<b>Display*</b>
01 <sub>hex</sub> 23 <sub>hex</sub> 00 <sub>hex</sub>	11 <sub>hex</sub> 07 <sub>hex</sub> FF <sub>hex</sub>	L1: F 2047

\*: EXDUL-336E only!

## 6.9.11 Writing the Output Port Reset Value

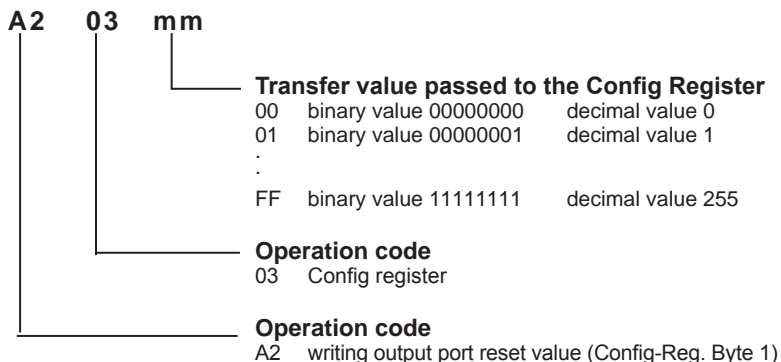

### For example:

At the next start or at a reset of the module, the relay contacts shall be made at channel OUT02, OUT03, OUT04 and OUT06, the relay contacts of all other channels remain broken (relay contact made = 1; relay contact broken = 0)

Output channel	OUT07	OUT06	OUT05	OUT04	OUT03	OUT02	OUT01	OUT00
Terminal screw	8	7	6	5	4	3	2	1
Switching status	0	1	0	1	1	1	0	0
Display*	A	E	A	E	E	E	A	A

### Write

A2<sub>hex</sub> 03<sub>hex</sub> 5C<sub>hex</sub>

### Response

A2<sub>hex</sub> 03<sub>hex</sub> 5C<sub>hex</sub>

\*: EXDUL-336E only!

### 6.9.12 Writing Display Mode Byte\*

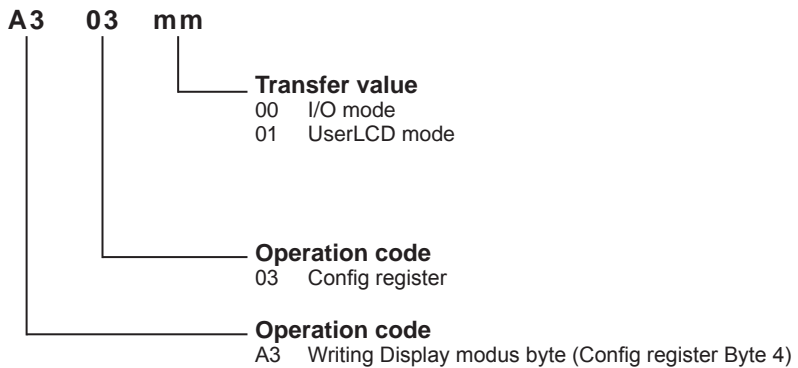

The display mode byte determines, which data is displayed in a flashing or rotational mode, respectively, alternating with communication or refresh display.

\*: EXDUL-336E only!



## 6.9.13 Writing LCD Contrast Value\*

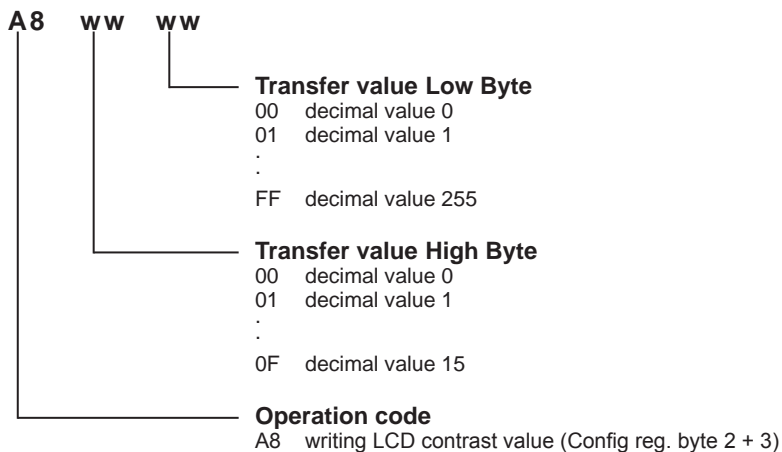

Contrast value = transfer value high-byte x 256 + transfer value low-byte (0F FF = 4095)

### For example:

Display contrast peak value (maximum brightness)

#### Write

A8<sub>hex</sub> 0F<sub>hex</sub> FF<sub>hex</sub>

#### Response

A8<sub>hex</sub> 0F<sub>hex</sub> FF<sub>hex</sub>

Display contrast average value

#### Write

C2<sub>hex</sub> 07<sub>hex</sub> FF<sub>hex</sub>

#### Response

C2<sub>hex</sub> 07<sub>hex</sub> FF<sub>hex</sub>

\*: EXDUL-336E only!

### 6.9.14 Writing in User LCD Area\*

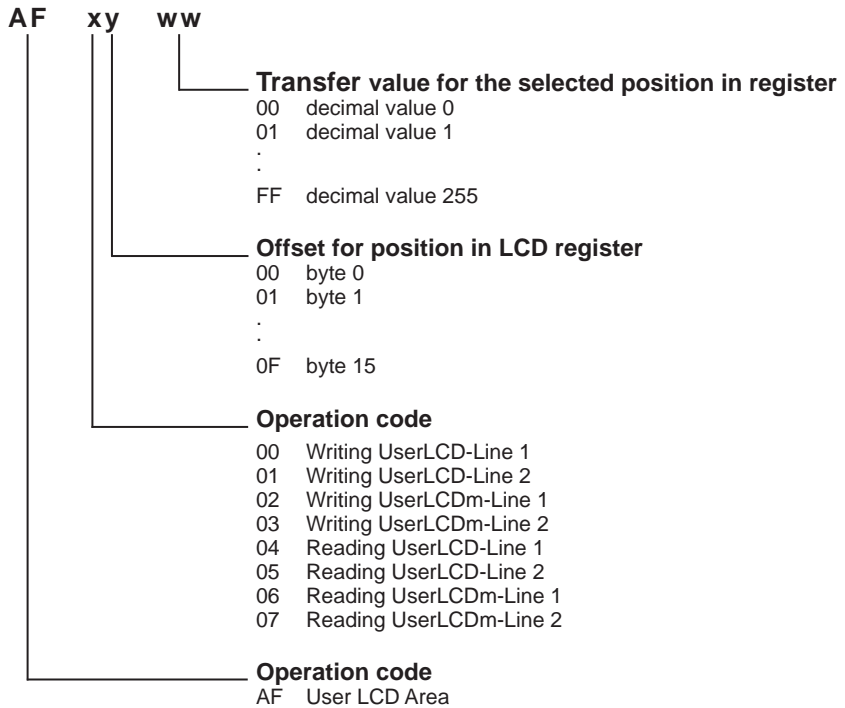

\*: EXDUL-336E only!

**For example:**

Write the word STEUERUNG into UserLCD-Line 1

**Write**

AF<sub>hex</sub> 00<sub>hex</sub> 53<sub>hex</sub>  
AF<sub>hex</sub> 01<sub>hex</sub> 54<sub>hex</sub>  
AF<sub>hex</sub> 02<sub>hex</sub> 45<sub>hex</sub>  
AF<sub>hex</sub> 03<sub>hex</sub> 55<sub>hex</sub>  
AF<sub>hex</sub> 04<sub>hex</sub> 45<sub>hex</sub>  
AF<sub>hex</sub> 05<sub>hex</sub> 52<sub>hex</sub>  
AF<sub>hex</sub> 06<sub>hex</sub> 55<sub>hex</sub>  
AF<sub>hex</sub> 07<sub>hex</sub> 4E<sub>hex</sub>  
AF<sub>hex</sub> 08<sub>hex</sub> 47<sub>hex</sub>

**Response**

AF<sub>hex</sub> 00<sub>hex</sub> 53<sub>hex</sub>  
AF<sub>hex</sub> 01<sub>hex</sub> 54<sub>hex</sub>  
AF<sub>hex</sub> 02<sub>hex</sub> 45<sub>hex</sub>  
AF<sub>hex</sub> 03<sub>hex</sub> 55<sub>hex</sub>  
AF<sub>hex</sub> 04<sub>hex</sub> 45<sub>hex</sub>  
AF<sub>hex</sub> 05<sub>hex</sub> 52<sub>hex</sub>  
AF<sub>hex</sub> 06<sub>hex</sub> 55<sub>hex</sub>  
AF<sub>hex</sub> 07<sub>hex</sub> 4E<sub>hex</sub>  
AF<sub>hex</sub> 08<sub>hex</sub> 47<sub>hex</sub>

Calling the command A3<sub>hex</sub> 03<sub>hex</sub> 01<sub>hex</sub> induces the display to show the UserLCD area

\*: EXDUL-336E only!

## 7. Specifications

### Digital optocoupler inputs

Channels	10 inputs with galvanic isolation common ground connection (cathodes connected) 2 of the channels programmable as counting inputs optocoupler with integrated Schmitt-Trigger function diodes
Galvanic isolation	
Overvoltage protection	
Input voltage range	high = 10 .... 30 V low = 0 .... 3 V
Input frequency	max. 10 kHz

### Digital relay outputs

Channels:	8 channels galvanically isolated Relay contact A with one terminal connection each Relay contact B with common terminal connection
Contact:	1 NO contact
Contact current rating:	max. 2 A
Contact voltage rating:	max. 30 V AC / 30 V DC
Power rating:	max. 60 VA / 60 W
Mechanical lifetime:	max. 20 * 10 <sup>6</sup> switching cycles without load
Contact lifetime:	2 A, 30 VAC at NO contact, max. 10 <sup>6</sup> switching cycles
Operating cycles under load:	max. 10/min
Operating cycles without load:	max. 1200/min
Switching time:	typ. 5 ms
Release time:	typ. 2 ms
Bounce time N/O contact:	< 1 ms

### Counter

Channels:	2 programmable digital 16-bit counters (2 of the 10 input optocouplers are assigned)
Counting frequency:	max. 5 kHz

### LCD Display (EXDUL-336E only)

Display:	Matrix display with 2 lines and 16 columns performing 16 characters each line
Programmable as:	I/O status display UserLCD display

**Power Supply**

Internal via USB Port:	+5V (it may be necessary to release the operating system of your computer to get the appropriate power consumption).
External power supply:	+10 V...+24 V (using an external power supply will automatically interrupt the power supply via USB port)

**USB interface**

USB 2.0 compatible  
USB connection Plug-and-Play  
(hot pluggable)

**Module connections**

1 \* 24pin screw terminal  
1 \* USB port type B

**USB connecting cable**

1 \* USB plug type A  
1 \* USB plug type B

**Product dimensions**

105 mm x 89 mm x 59 mm (l x b x h)

**Casing**

Insulated casing with integrated snap-on technology for DIN EN top-hat rail mounting  
Suitable for control and engineering technology mounted to control and distribution boxes, for surface mounting or mobile use on a desk.

# 8. Examples for circuitry

## 8.1 Wiring of the Inputs

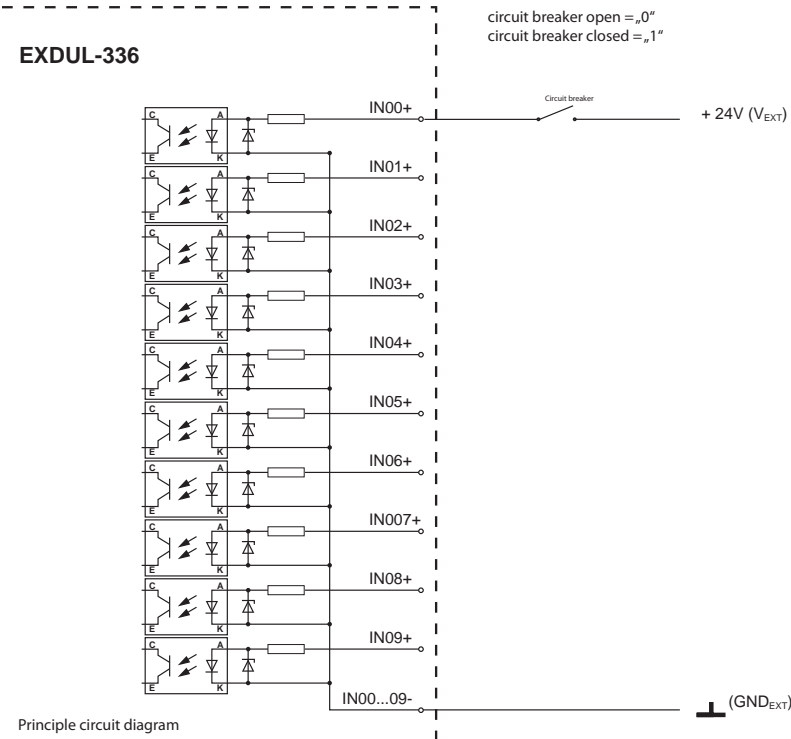

### 8.2 Wiring of the Outputs

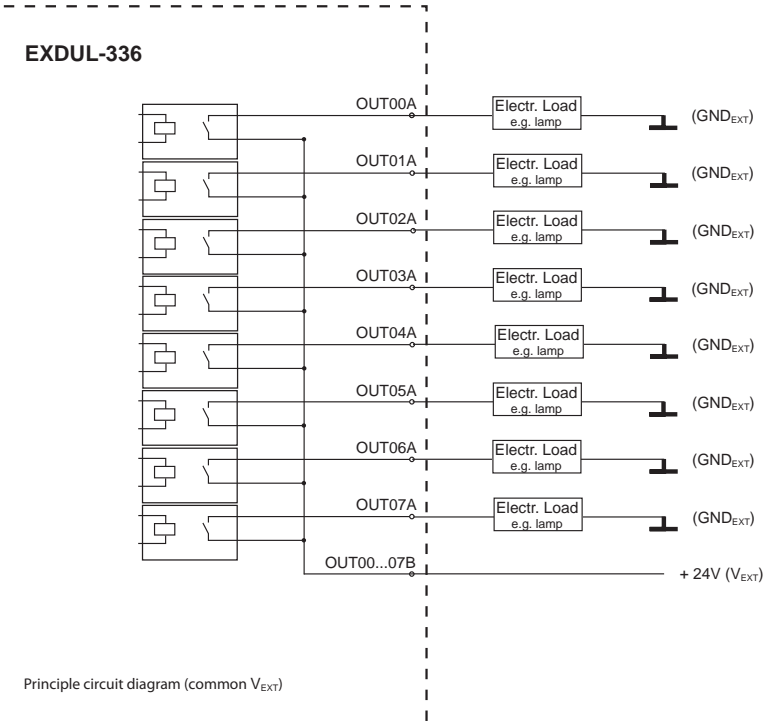

**EXDUL-336**

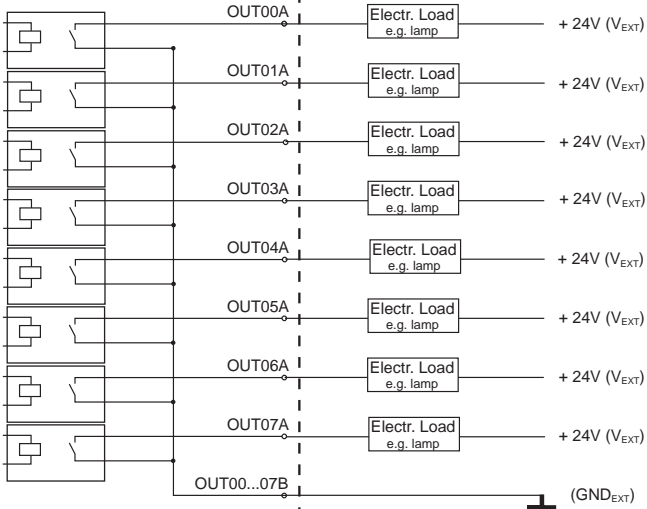

Principle circuit diagram (common GND)



## 9. ASCII Table

Hex	Dec	Binary	sign
00	0	00000000	
01	1	00000001	
02	2	00000010	
03	3	00000011	
04	4	00000100	
05	5	00000101	
06	6	00000110	
07	7	00000111	
08	8	00001000	
09	9	00001001	
0A	10	00001010	
0B	11	00001011	
0C	12	00001100	
0D	13	00001101	
0E	14	00001110	
0F	15	00001111	
10	16	00010000	
11	17	00010001	
12	18	00010010	
13	19	00010011	
14	20	00010100	
15	21	00010101	
16	22	00010110	
17	23	00010111	
18	24	00011000	
19	25	00011001	
1A	26	00011010	
1B	27	00011011	
1C	28	00011100	
1D	29	00011101	
1E	30	00011110	
1F	31	00011111	
20	32	00100000	[Blank]
21	33	00100001	!
22	34	00100010	"
23	35	00100011	#
24	36	00100100	\$
25	37	00100101	%
26	38	00100110	&
27	39	00100111	'

Hex	Dec	Binary	sign
28	40	00101000	(
29	41	00101001	)
2A	42	00101010	*
2B	43	00101011	+
2C	44	00101100	,
2D	45	00101101	-
2E	46	00101110	.
2F	47	00101111	/
30	48	00110000	0
31	49	00110001	1
32	50	00110010	2
33	51	00110011	3
34	52	00110100	4
35	53	00110101	5
36	54	00110110	6
37	55	00110111	7
38	56	00111000	8
39	57	00111001	9
3A	58	00111010	:
3B	59	00111011	;
3C	60	00111100	<
3D	61	00111101	=
3E	62	00111110	>
3F	63	00111111	?
40	64	01000000	@
41	65	01000001	A
42	66	01000010	B
43	67	01000011	C
44	68	01000100	D
45	69	01000101	E
46	70	01000110	F
47	71	01000111	G
48	72	01001000	H
49	73	01001001	I
4A	74	01001010	J
4B	75	01001011	K
4C	76	01001100	L
4D	77	01001101	M
4E	78	01001110	N
4F	79	01001111	O

Hex	Dec	Binary	sign
50	80	01010000	P
51	81	01010001	Q
52	82	01010010	R
53	83	01010011	S
54	84	01010100	T
55	85	01010101	U
56	86	01010110	V
57	87	01010111	W
58	88	01011000	X
59	89	01011001	Y
5A	90	01011010	Z
5B	91	01011011	[
5C	92	01011100	
5D	93	01011101	]
5E	94	01011110	^
5F	95	01011111	~
60	96	01100000	`
61	97	01100001	a
62	98	01100010	b
63	99	01100011	c
64	100	01100100	d
65	101	01100101	e
66	102	01100110	f
67	103	01100111	g
68	104	01101000	h
69	105	01101001	i
6A	106	01101010	j
6B	107	01101011	k
6C	108	01101100	l
6D	109	01101101	m
6E	110	01101110	n
6F	111	01101111	o
70	112	01110000	p
71	113	01110001	q
72	114	01110010	r
73	115	01110011	s
74	116	01110100	t
75	117	01110101	u
76	118	01110110	v
77	119	01110111	w
78	120	01111000	x
79	121	01111001	y
7A	122	01111010	z
7B	123	01111011	{

Hex	Dec	Binary	sign
7C	124	01111100	
7D	125	01111101	}
7E	126	01111110	
7F	127	01111111	
80	128	10000000	
81	129	10000001	
82	130	10000010	
83	131	10000011	
84	132	10000100	
85	133	10000101	
86	134	10000110	
87	135	10000111	
88	136	10001000	
89	137	10001001	
8A	138	10001010	
8B	139	10001011	
8C	140	10001100	
8D	141	10001101	
8E	142	10001110	
8F	143	10001111	
90	144	10010000	
91	145	10010001	
92	146	10010010	
93	147	10010011	
94	148	10010100	
95	149	10010101	
96	150	10010110	
97	151	10010111	
98	152	10011000	
99	153	10011001	
9A	154	10011010	
9B	155	10011011	
9C	156	10011100	
9D	157	10011101	
9E	158	10011110	
9F	159	10011111	
A0	160	10100000	
A1	161	10100001	
A2	162	10100010	
A3	163	10100011	
A4	164	10100100	
A5	165	10100101	
A6	166	10100110	
A7	167	10100111	

Hex	Dec	Binary	sign
A8	168	10101000	
A9	169	10101001	
AA	170	10101010	
AB	171	10101011	
AC	172	10101100	
AD	173	10101101	
AE	174	10101110	
AF	175	10101111	
B0	176	10110000	
B1	177	10110001	
B2	178	10110010	
B3	179	10110011	
B4	180	10110100	
B5	181	10110101	
B6	182	10110110	
B7	183	10110111	
B8	184	10111000	
B9	185	10111001	
BA	186	10111010	
BB	187	10111011	
BC	188	10111100	
BD	189	10111101	
BE	190	10111110	
BF	191	10111111	
C0	192	11000000	
C1	193	11000001	
C2	194	11000010	
C3	195	11000011	
C4	196	11000100	
C5	197	11000101	
C6	198	11000110	
C7	199	11000111	
C8	200	11001000	
C9	201	11001001	
CA	202	11001010	
CB	203	11001011	
CC	204	11001100	
CD	205	11001101	
CE	206	11001110	
CF	207	11001111	
D0	208	11010000	
D1	209	11010001	
D2	210	11010010	
D3	211	11010011	

Hex	Dec	Binary	sign
D4	212	11010100	
D5	213	11010101	
D6	214	11010110	
D7	215	11010111	
D8	216	11011000	
D9	217	11011001	
DA	218	11011010	
DB	219	11011011	
DC	220	11011100	
DD	221	11011101	
DE	222	11011110	
DF	223	11011111	
E0	224	11100000	
E1	225	11100001	
E2	226	11100010	
E3	227	11100011	
E4	228	11100100	
E5	229	11100101	
E6	230	11100110	
E7	231	11100111	
E8	232	11101000	
E9	233	11101001	
EA	234	11101010	
EB	235	11101011	
EC	236	11101100	
ED	237	11101101	
EE	238	11101110	
EF	239	11101111	
F0	240	11110000	
F1	241	11110001	
F2	242	11110010	
F3	243	11110011	
F4	244	11110100	
F5	245	11110101	
F6	246	11110110	
F7	247	11110111	
F8	248	11111000	
F9	249	11111001	
FA	250	11111010	
FB	251	11111011	
FC	252	11111100	
FD	253	11111101	
FE	254	11111110	
FF	255	11111111	

## 10. Release Notes

### Firmware Version 4.05

- Speed optimization
- Reset command removed
- Modifications upon accessing to the LCD display
- New commands for accessing to single relay channels and for reading of the relay output port

## 11. Product Liability Act

### Information for Product Liability

The Product Liability Act (Act on Liability for Defective Products - Prod-HaftG) in Germany regulates the manufacturer's liability for damages caused by defective products.

The obligation to pay compensation can be given, if the product's presentation could cause a misconception of safety to a non-commercial end-user and also if the end-user is expected not to observe the necessary safety instructions handling this product.

It therefore always must be verifiable, that the not-commercial end-user was made familiar with the safety rules.

In the interest of safety, please always advise your non-commercial customer of the following safety instructions:

### Safety instructions

The valid VDE-instructions must be observed, when handling products that come in contact with electrical voltage.

Especially the following instructions must be observed:  
VDE100; VDE0550/0551; VDE0700; VDE0711; VDE0860.

The instructions are available from:

Vde-Verlag GmbH  
Bismarckstr. 33  
10625 Berlin

- \* unplug the power cord before you open the unit or make sure, there is no current to/in the unit.
- \* You only may start up any components, boards or equipment, if they are installed inside a secure touch-protected casing before. During installation there must be no current to the equipment.
- \* Make sure that the device is disconnected from the power supply before you use any tools on any components, boards or equipment. Any electric charges stored in any components in the device are to be discharged prior.
- \* Voltaged cables or wires, which are connected with the unit, the components or the boards, must be tested for insulation defects or breaks. In case of any defect the device must be immediately taken out of operation until the defective cables are replaced.
- \* When using components or boards you must strictly comply with the characteristic data for electrical sizes shown in the corresponding description
- \* As a non-commercial end-user, if it is not clear whether the electrical characteristic data given in the provided description is valid for a component you must consult a specialist.

The compliance with building and safety instructions of every kind (VDE, TÜV, industrial injuries corporation, etc.) are entirely subject to the user/customer.

## 12. CE Declaration of Conformity

This is to certify, that the products

**EXDUL-336E EDV-Nummer A-385340**  
**EXDUL-336S EDV-Nummer A-385320**

comply with the requirements laid down by the EC directives. This declaration will lose its validity, if the instructions given in this manual for the intended use of the products are not fully complied with.

EN 5502 Class B  
IEC 801-2  
IEC 801-3  
IEC 801-4  
EN 50082-1  
EN 60555-2  
EN 60555-3

The following manufacturer is responsible for this declaration:

Messcomp Datentechnik GmbH  
Neudecker Str. 11  
83512 Wasserburg

given by

Dipl.Ing.(FH) Hans Schnellhammer

Wasserburg, 29.10.2008



---

## Reference System for Intended Use

The multi functional modules EXDUL-336E and EXDUL-336S are not stand-alone devices. The CE-conformity only can be assessed when using additional computer components simultaneously. Thus the CE conformity only can be confirmed when using the following reference system for the intended use of the multi functional modules:

Control Cabinet:	Vero IMRAK 3400	804-530061C 802-563424J 802-561589J
19" Casing:	Vero PC Casing	145-010108L
19" Casing:	Additional Electronic	519-112111C
Motherboard:	GA-586HX	PIV 1.55
Floppy-Controller:	on Motherboard	
Floppy:	TEAC	FD-235HF
Grafic Card:	Advantech	PCA-6443
Interfaces:	EXDUL-336E	A-385340
	EXDUL-336S	A-385320